



**INTERNATIONAL SCIENTIFIC
AND TECHNICAL INTERNET CONFERENCE**

**“INNOVATIVE DEVELOPMENT OF
RESOURCE-SAVING TECHNOLOGIES OF
MINERAL MINING AND PROCESSING”**

**PETROȘANI, ROMANIA
DECEMBER 14, 2018**

ONLINE BOOK OF ABSTRACTS

**Universitas Publishing
Petroșani, 2018**

UDC 622:658.589 (063)

International Scientific and Technical Internet Conference
“Innovative Development of Resource-Saving Technologies of
Mineral Mining and Processing”. Online Book of Abstracts. -
Petroșani, Romania: UNIVERSITAS Publishing, 2018. – 221p.

ISBN 978-973-741-616-2 © Composite author, 2018 (Online)

The materials of the conference are in the authors' edition. References are obligatory in case of full or partial reproduction of the abstracts content. The abstracts contributors including their scientific achievements and statements reserve all rights

The conference organizing committee includes:

Co-chairmen:

- **Roland Moraru**, Professor, PhD (Habil.Eng.), Research Vice-Rector, University of Petrosani, Romania.
- **Vsevolod Kalinichenko**, Academician of Academy of Mining Sciences of Ukraine, DSc. (Engineering), Professor of Kryvyi Rih National University, Ukraine.

Vice-chairman:

- **Serhii Chukharev**, PhD (Engineering), Associate Professor of the department of underground mining of Kryvyi Rih National University, Ukraine.

Committee Members:

- **Sorin-Mihai Radu**, Professor, Ph.D., Rector University of Petroșani, Romania;
- **Mykola Stupnik**, Academician of Academy of Mining Sciences of Ukraine, DSc. (Engineering), Professor, Rector of Kryvyi Rih National University, Ukraine;
- **Eduard Edelhauser**, Professor, Ph.D., Vice-Rector University of Petroșani, Romania;
- **Codruta Dura**, Assoc. Prof. Ph.D., Vice-Rector University of Petroșani, Romania;
- **Monica Leba**, Professor, Ph.D., Director of the Doctoral School University of Petroșani, Romania;
- **Anfreea Ionică**, Professor, Ph.D., Dean of the Faculty of Mines University of Petroșani, Romania;
- **Imola Drigă**, Assoc. Prof. Ph.D., Dean of the Faculty of Sciences University of Petroșani, Romania;
- **Iosif Dumitrescu**, Assoc. Prof. Ph.D., Dean of the Faculty of Mechanical and Electrical Engineering University of Petroșani, Romania.
- **Siarhei Onika**, DSc. (Engineering), Professor, Head of the department of mining operations of Belarusian National Technical University, Republic of Belarus;
- **Georgi Stoyanchev**, DSc. (Engineering), Professor, University of Mining and Geology "ST. IVAN RILSKI", Bulgaria;
- **Serhii Zhukov**, Academician of Academy of Mining Sciences of Ukraine, DSc. (Engineering), Professor, Head of the department of open pit mining of Kryvyi Rih National University, Ukraine.
- **Khalidilla Yussupov**, DSc. (Engineering), professor, Kazakh National Research Technical University named after K.I. Satpaev, Republic of Kazakhstan;
- **Dr. Tafsir Dialo**, Managing Director of Polytechnic Institute of Gamal Abdel Nasser University of Conakry, Republic of Guinea;
- **Dr. C. Farsi**, University of M'sila, Algeria;
- **Sayyidjabbor Sayyidkosimov**, PhD (Engineering), Head of the Department Surveying and geodesy of Tashkent State Technical University named by Islom Karimov, Republic of Uzbekistan.

Table of contents

Table of contents	4
Vilkul Yu.G. Greeting to participants of the conference in the view of actual mining science problems	8
SECTION "UNDERGROUND MINING"	
Stupnik M.I., Kalinichenko V.A., Fedko M.B Dust survey at bucket hoisting in glavnyi shaft of novokonstantinovskaya underground mine at se "VostGOK"	11
Malanchuk Z.R., Zaiets V.V., Vasylichuk O.Yu. Features gas content and production of coal bed methane in the Lviv-volyn coal basin	13
Krupnik L. A., Yu. N. Shaposhnik, Shaposhnik S. N. Of ore excavation in protective pillars in Suzdal deposit	16
Skrzypkowski K., Korzeniowski W., Zagórski K. Diameters of bolting holes for underground mines in the area of legnica-głogów copper belt	19
Drizhd N.A., Kamarov R.K., Zamaliyev N.M. Criteria of the need for application of mine degasing	22
Morgun A., Chukharev S. Concentrated charge blasting in iron ore mining at kryvyi rih iron ore basin	24
Kalybekov T., Rysbekov K.B., Soltabayeva S.T. The study of the influence of preparedness of the ore reserves on the planning of underground mining operations ...	26
Sholokh M. V., Sergieieva M. P. Taking into account of amount and quality of attracted in the booty of balanced on maintenance quality indexes minerals of supplies ..	29
Nazarमतov A.A., Rahmatov A.A., Saidov M.K. Estimation of the effect of resource-saving technologies on the efficiency of ore mining in the underground deposit development in the conditions of the republic of tajikistan	32
Drizhd N.A., Kamarov R.K., Zamaliyev N.M. Methane volumes contained in coal seams	35
Krupnik L.A. Shaposhnik Yu. N., Shaposhnik S. N. The substantiation of parameters of the barrier pillar between the open pit bottom and stoping voids in terms of the suzdal mine	37
Malanchuk Ye.Z., Khrystyuk A.O., Zagorovskii V.N. Features of control of the hydromechanical amber extraction process	41
Shepel O.L. Concerning a definition question conditions of an ore drawing, which promote improvement technologies of mining of ore deposits systems of a sublevel caving of ore	44
Drizhd N.A., Kamarov R.K., Zamaliyev N.M. Technology perfection for suppression of sulfur - containing gas at underground mining works	47
Sholokh M. V. Planning of development of mountain works in the process of exploitation of balance-industrial supplies	50
Osenniy V.Ya., Osennaya N.V., Kholiavik O.V. About resource-saving technologies of development of magnetite quartzites	53
Petlovanyi M.V., Ruskykh V.V., Sai K.S. Challenges of underground mining of steeply pitching deposits with stowing in anomalous geological environment	56
SECTION "OPEN PIT MINING"	
Skachkov A.A., Zhukov S.A., Titov D.A. Symmetric blasting of rocks in conditions of open pit with narrow working fields	61

<i>Onika S.G., Naryzhnova E.J.</i> Seismically safe parameters of explosions in a quarry of natural stone	64
<i>Tomiczek K.</i> An attempt to determine and verify the properties of a dump material	66
<i>Moussa Zaoui, Chouki Farsi, Serhii Zhukov,</i> Experimental study and numerical modeling of ductile tearing in a welded joint	70
<i>Vusyk O.O., Pyzhyk A.M.</i> Experience of operation of mining surface miners the development of half-rocky rocks and rocky rocks	73
<i>Sholokh M. V., Kobzar V. V.</i> Influence of losses of balance-industrial supplies and obstruction of content of quality indexes of minerals is in iron-ore mass on the process of averaging out	75
<i>Kalybekov T., Rysbekov K.B., Sandibekov M.N.</i> Studying of the condition of the mined lands on open-cast minings and their recultivation	79
<i>Bajić S., Glušević B.</i> Analysis of influence of blasting at open pit mines on surrounding built objects and environment	82
<i>Korniienko V.Ya., Semeniuk V.V., Romanovskiy V. Ya.</i> Exploration of the efficiency of development of amber deposits in a combined method	85
<i>Nguyen Anh Tuan</i> Determining for an output capacity of dimension stone exploitation from the computer simulations to generate the fracture network in 3D	88
<i>Adamchuk A.A., Shustov O.O., Hladun O.P.</i> Systematization of career vehicles and justification of their effective applications in the conditions of finalizing steep deposits	90
<i>Kozioł W., Baic I.</i> Extraction of rock raw materials in Poland	93
<i>Vusyk O.O., Pyzhyk A.M.</i> Study of technology to mining surface the rock mass of mining combines	95
<i>Kalchuk S.V., Zhukov S.O.</i> Features of the non-explosive extraction of a dimension stone during opencast mining	97
<i>Frolov A. A., Kosenko T. V., Zhukova N. I.</i> Bases of destruction of rocks in natural conditions of reservation	100
<i>Sholokh M. V.</i> Optimization of correlation of losses of balance-industrial supplies and obstruction of content of quality indexes of minerals is in the stream of iron-ore mass	103
<i>Lutsenko S.A., Shvets E.N., Martyniuk M.V.</i> Enhancement of methods of determining the boundaries of opencast mines	106
<i>Hryhoriev Y.I., Navitniy Y.M., Fedorenko S.O.</i> Method of formation of technogenic deposits of bulk type using orepass	108
<i>Slobodyanyuk V.K., Penkal S.Yu.</i> shovel reloading points for the road and rail transport	110
<i>Tomiczek K.</i> Stability simulations of the multi-leveler dumps made of mining waste .	113
<i>Bubnova O.A.</i> Geomechanical processes in disturbed and technogenic environments and their effects on the environment in the mining regions	117
<i>Vusyk O.O., Pyzhyk A.M.</i> Conducting open development of surface mining rocks use of mining combines	120

SECTION “SHAFT SINKING AND DRIFTING”

<i>Khalymendyk O., Storchak G., Shapoval V.</i> The failure criteria for saturated rocks with excessive pored fluid/gas pressures	122
<i>Sakhno S.I., Yanova L.A., Pischikova O.V.</i> Application of sintering dust for the increase of cement durability	124
<i>Vapnichna V.V., Shaidetska L. V.</i> Concept of geomonitring in the megapolis conditions	126
<i>Kamenets V.I., Kobylanskyi O.O., Fedalchenko M.O.</i> Development of the mine workings construction technologies at the krasnoarmiisk coal industrial area mines	129

SECTION “MINE SURVEYING”	132
<i>Sholokh M. V.</i> An analysis of surveyor control of losses of balance-industrial supplies is at mastering	132
<i>Kamenets V.I., Epshteyn V.O., Cherman Y.O.</i> Surveying support of the undermining of transport facilities at pjsc “Shakhtoupravlinnya “Pokrovske”	135
<i>Sholokh M. V., Litvinenko V. A.</i> Indexes of the use of bowels of the earth are with taking into account of sibalance on	138
SECTION “LABOT SAFETY”	141
<i>Morkun V.S., Morkun N.V., Hryshchenko S.M.</i> Synthesis of identification algorithms of static and dynamic characteristics of automatic control object	141
<i>Alaba O.C.</i> Design of air and dust quality measurement and monitoring device for mineral industry	143
<i>Drizhd N.A., Kamarov R.K., Zhumabekova A.E.</i> Hydrogen and sulfur gas effect on the environment	144
<i>Chobotko I.I., Tynyna S.V.</i> Methods and means of localization of focals of self-ignition of specific dumps	147
<i>Filatiev A E., Filatiev M. Antoshchenko M.</i> Effect of the speed of movement of treatment faces (coal mining) on the gas release from mining sources	150
<i>Tretiakova L.D., Mitiuk L.O., Tokar G. M.</i> Evaluation risks that occur during the use of protective clothing for the workers of the mining industry	152
<i>Khudyk M.V.</i> Ways to increase the effectiveness of dust capture by dusting chambers	155
<i>Oleynichenko O.A., Filatyeva E.M., Sokolenko V.M.</i> Influence of face advance rate on outgassing treatment in degassing systems	158
SECTION “MINERAL PROCESSING”	161
<i>Kuvaev V.N., Mladetsky I.K., Kuvaev Ya.G.</i> The importance of the mineral demagnetization at separation	161
<i>Shautenov M.R., Askarova G.E., Nurdan M.E.</i> Enrichment of sulfide copper-molybdenum ore and production of collective copper-molybdenum concentrate	164
<i>Matsui A.N., Kondratets V.A.</i> Analysis of the operation of a mechanical single-spiral classifier as a control object	165
<i>Blaschke W., Baic I.</i> Dry deshaling of coking coal before its enrichment in jigs	168
<i>Nigmatulin A.M., Kan A.N., Yefimenko S.A.</i> Effective «online» ore quality control with the help of edxrf ore-controlling stations on the conveyors of llc «Kazakhmys corporation» concentrate plants and mines	172
<i>Umarova I.K., Aminjanova S.I.</i> Studying the material composition of the ore of deposit handiza	175
<i>Aminjanova S.I.</i> Studying the enrichment of iron ore samples from the mingbulak deposit	178
<i>Salijanova G.K.</i> The results of enrichment of samples of ore deposits sarycheku using traditional and local reagent “PS”	181
<i>Shautenov M.R., Nurdan M.E. Askarova G.E.</i> Analysis of gravity-flotation enrichment of refractory gold ores combined with metallurgical processes	184
<i>Chernenko V.Yu., Astrelin I.M. Tolstopalova N.M.</i> Enrichment and leaching of non-ferrous metal ores and phosphate ores with organic acids	185
<i>Korchuganova O.M., Lyubimova-Zinchenko O.V., Zaika R.G.</i> The enreaching of clay as raw mineral for pigments	188

SECTION “MINING MACHINES AND EQUIPMENT”	191
<i>Makharadze L.I.</i> Methods and means of ensuring safe and reliable operation of pressure pipelines of hydrotransport systems	191
<i>Yatsun V.</i> Experimental research of rectilinear translational vibrations of a vibrator platform by a ball autobalancer	193
<i>Monastyrskiy Ju.A., Potapenko V.V., Bondar I.V.</i> Adaptive system of technical operation of open pit trucks	194
<i>Kourouma Ibrahima Kalil, Pozdniakov Valerii, Bah Brahima</i> Amelioration en qualite de la production bauxitique des gisements de la compagnie des bauxites de guinee (CBG), republique de Guinee	196
<i>Pakhomov V.I., Pristinskiy M. G. Pristinskiy S.M.</i> The way of the complete utilization of a service life of the large-dimension tires of career dump trucks	198
<i>Cheberyachko I.M., Trofymova O.P.</i> Factors effecting the efficiency of the compressor plant operation	200
<i>Popovych O.M., Golovan I.V.</i> Mathematical software with increased efficiency for designing induction motors of electromechanical systems of the mining industry	202
<i>Zaichenko S.V., Stovpnik S. M., Shevchuk S. P.</i> Development of mechatronic diagnostics pipelines	205
<i>Strilets O.R.</i> Justification of the structure and operation principle of the device for speed change by the epicyclic gear train with a closed loop hydrosystem and its energy efficiency	208
<i>Mnukhin A.G., Hituliar A.A.</i> New methods of seismic exploration on the basis of hydraulic blasting technologies	211
<i>Strilets V.M., Koziar M.M., Volsky V.A.</i> Justification of the design, structure and principle of operation of the brake in the form of a closed loop hydrosystem and its installation on the drive shaft	214
<i>Banzak O.V., Banzak G.V.</i> Imitational statistical model of technical service processes of mining equipment	216
<i>Vynohradova O.P., Vasylchuk O.S., Maystrenko A.L.</i> The mechanism of wear of diamond-containing composite in drilling tools	218

UDC 622.274

VILKUL Yu.G., Doctor of Sciences (Engineering), professor,
President of Mining Sciences Academy of Ukraine

GREETING TO PARTICIPANTS OF THE CONFERENCE IN THE VIEW OF ACTUAL MINING SCIENCE PROBLEMS

Dear Colleagues!

First of all, I would like to greet you as participants of this international scientific conference.

Let me take this opportunity to thank you for all your efforts and your attention!

In order to develop the mining theory and technology, as well as the methods of mining operations scientific support for surface and underground mining of mineral resources, coal and ore processing, improvement of management and planning systems, enhancement of labor safety and environmental protection in mining regions, innovative development of mining equipment, economic and social problems of mineral and raw-material clusters, and cooperation between mining universities and research centers, as well as other issues are discussed at this conference.

What is the specificity and features of our time in the raw material aspect?

The main thing that bothers us is that the last few years the iron ore market has been in a depressed state. Iron ore prices have reached their lowest levels in the past 10 years. Lower prices are occurring against the backdrop of rising surplus raw materials on the world market.

Similarly, in 2015, iron ore prices also fell by more than 40%.

The maximum price for iron ore was recorded in 2011 and amounted to 191.7 dollars/ton, the minimum price for these raw materials was recorded in 1988 at 10.51 dollars / ton

The peaks of the last four cycles are about 30 years behind each other. Each of them consisted of a 10-year rise, followed by a precipitous decline, which lasted about five years, which turned into a relatively smooth decline, which lasted another 15 years. Peaks were recorded in 1917, 1951, 1980, and 2011. The lowest points

occurred in 1931, 1971, 2002. If the current cycle repeats the previous ones, then the next minimum cycle or turning point will be in 2030. This sets up a chain involving several complications.

Let's take a closer look at this problem.

Ukraine is a uniquely rich region in the world in mineral resources. With an area of the country of approximately 0.03% of the area of the earth's surface, 5% of the world production of mineral resources is extracted in the country. The deposits of manganese and 80% of its world production, 14% of iron ore, 7% of coal are world famous. Only a few years ago, we produced almost 90% of titanium, more than half of mercury, graphite, 90% of native sulfur, 70% of facing stone, etc. We have enough reserves. And the main conclusion that suggests itself when deciding on the rational use of the country's mineral resources is that Kryvbas and now, of course, as before, remains the basis of the iron ore industry of Ukraine and the main issue here is the integrated use of ore and ecology.

The bowels of the Krivoy Rog basin, unfortunately, are used irrationally. Despite the fact that in the mined ore mass contains several types of mineral raw materials, only one is used - iron ore. The rest are sent to waste and stored in dumps and tailings, creating new - man-made deposits. As a result of mining operations in Krivbass, more than 34 thousand hectares of land were disturbed. Of the 585 sq. km of the territory, almost 40 sq. km, there are open pits and a collapse zone, and at 70 sq. km there are tailing sites with more than 3 billion tons of rock mass. More than 70 sq. km is under waste dumps - more than 9 billion tons of overburden. For only 5 GOKs of Krivbass, the total land allotment is about 34 thousand hectares. The dump heights are already more than 120 m, tailing dams are about 90 m. In the region, as a result of mining and smelting operations, more than 600 thousand tons of dust and more than 1 million m³ of harmful and highly toxic gases are released into the atmosphere. This leads to the fact that in many areas of the city the concentration of dust and harmful substances far exceeds the maximum permissible norms. To this is added the complicated problem of underground spaces worked out almost completely by underground mining.

In this regard, the activities of the community of our miners, coordinated by the Academy of Mining Sciences, provides, first of all, the development of environmentally friendly ore mining

technologies in the deep quarries of Krivbass. Every year, the Academy participates in the implementation of a long-term program to solve environmental problems of Krivbass and improve the state of the environment for 2011-2022. The program “Development of equipment and technology of reclamation of lands disturbed by mining enterprises, which will ensure their use in the national economy of Ukraine” is becoming extremely necessary.

The Academy consists of:

Total members - 285, including 26 foreign members.

- Academicians - 122, Corresponding members - 157;

- Doctors of sciences - 168, Doctors of Philosophy - 111;

- Honorary members - 6.

Structurally, the Academy is divided into:

- 11 scientific and industrial complexes,

- 3 branches including one foreign Romanian regional office

- 3 scientific and technical centers,

- Ukrainian Association of Explosives Engineers.

Collective members of the Academy are 11 enterprises and institutions.

As can be seen from the structure, this is a powerful personnel potential uniting the scientific and production forces of the national economy of the country, which are able to solve the complex scientific and economic tasks of the mining complex of Ukraine at this time of crisis for the country.

The Academy plans to conduct research in the following main areas in the near future: enrichment of weakly oxidized quartzites; integrated and environment friendly development of mineral resources; combined open-underground mining of mineral deposits; integrated use of underground space; improvement of coal mine degassing processes and other urgent tasks and problems.

We are confident that the work performed allowed us to conduct research and development work.

This conference brought together leading scientists and specialists from enterprises and mining complexes in different countries. And this is a sure guarantee that we still have many great victories and achievements ahead.

I wish you all true creativity, of course, significant scientific results and the best of success!

Section “Underground Mining”

UDC 622.272: 622.6: 622.807

M.I. STUPNIK, Doctor of Sciences (Engineering), Professor,

V.A. KALINICHENKO, Doctor of Sciences (Engineering),

Professor,

M.B. FEDKO, PhD (Engineering), Assoc. Professor,

Kryvyi Rih National University, Ukraine

DUST SURVEY AT BUCKET HOISTING IN GLAVNYI SHAFT OF NOVOKONSTANTINOVSKAYA UNDERGROUND MINE AT SE “VOSTGOK”

Novokonstantinovskaya underground mine of the State Enterprise “VostGOK” is the largest in Europe in terms of uranium ore reserves. The deposit is opened by three shafts: *Glavnyi*, *Razvedyvatelno-Ekspluatatsionnyi №6 (RE-6)* and *Ventilatsionnyi-1*. With the designed annual output of 1,5 mln t of ore its real output makes about 330 thousand which is caused by the limited hoisting capacity of the shafts *RE-6* and *Ventilatsionnyi-1*.

One of the scenarios of increasing output of mining uranium ores at this mine considers use of *Glavnyi* for bucket hoisting. Simultaneously, it is used as a ventilating shaft and this causes a problem of dust pollution as the dust is blown off during hoisting. In this case, the current safety rules allow for maximum permissible concentration of dust not exceeding 0,6 mg/m³. So, the process of dust formation while bucket hoisting in the shaft was studied to determine the possible dust pollution level.

As the dust pollution level is in direct dependence on the coarseness of the ore hoisted in the bucket, its granulometric composition was first determined. The performed sieve analysis of uranium ore samples showed that fraction -1÷+0 mm content which is potentially the source of dust formation makes about 0,03%. This means that a БИСМ-4 bucket to be used contains 7-7,5 t of rock mass, 2-2,3 kg of which being the above mentioned fraction. Such assumption being of the stochastic nature, the actual weight of ore fines in a bucket may make from 1-1,5 to 3,5-4 kg. Thus, to ensure

observance of dust pollution norms even in the most unfavourable conditions, the worst case, i.e. the maximum -1÷+0 mm fraction content, was modeled.

Besides, such factors as moisture of ore and fines distribution were considered as well. The latter depends on bucket loading methods. The distribution is evener if a belt or a plate feeder is applied. Due to segregation when applying a vibrofeeder, there are 3-4 times fewer fines in the upper layer of the ore in the bucket. This produces considerable impacts on the dust level.

The research was conducted in the wind tunnel AT-2K-250/500. When modeling the process, it was important to comply with the similarity criteria such as rock particle sizes, the air flow rate, the kinematic coefficient of the medium viscosity. Change of the modeling scale causes the problem of these factors' compliance with real data. As the air tunnel diameter could not be changed but the air flow rate could be regulated, it was decided to place actual samples of rock mass of the granulometric composition characteristic of the mine into the stand and to measure the dustiness level at the speed of the air flow corresponding to the one in real conditions. The obtained data on the dustiness level in the model were adjusted considering the bucket-model area relationship, the amount of air moving through the shaft per time unit in real conditions and in the model.

The results of the laboratory studies, the forecast dust pollution rate in real conditions and possible excess of the rate permissible for these conditions are given in Table 1.

Table 1

Results of the laboratory studies of dust pollution at bucket hoisting

Bucket loading method	Rock mass properties	Dust pollution level		Excess of permissible dust pollution, times
		modeled, mg/m ³ ·s	calculated for real conditions, mg/m ³ ·s	
Belt or plate feeder	Natural moisture	12,0	6,5	10,8
	Watered bucket surface	3,6	2,0	3,3
	Bischofite-treated surface	0,6	0,3	0,5
Vibrofeeder	Natural moisture	3,2	1,7	2,9
	Watered bucket	0,8	0,44	0,7

	surface			
--	---------	--	--	--

As is seen, regardless of the bucket loading method, insufficient moisture of ore results in the excessive dust pollution.

When a belt or a plate feeder is applied to load the bucket, even if the upper layer of ore in the bucket is watered, excess of the permissible dust pollution rate will be 3-3,5 times as much. In this case, the ore surface should be treated with the bischofite-water solution which effectively binds fines and therefore prevents their blowing off during hoisting. Even sufficient natural moisture of ore (not less than 4%) or thorough watering of the ore in the bucket ensures dust level decrease up to 0,7 of the rate set for such conditions.

Thus, on the basis of the conducted studies of bucket hoisting to be applied in *Glavnyi* shaft, when designing the underground loading facility, application of the vibrofeeder should be provided for loading a bucket. Sufficient natural moisture of ore (not less than 4%) or thorough watering of the ore in the bucket ensures observance of the current dust pollution norms for the downcast air.

UDC 622.272.31: 622.33

Z.R. MALANCHUK, Doctor of technical sciences, professor

V.V. ZAIETS, Ph. D, associate professor

O.Yu. VASYLCHUK, Ph. D, associate professor,

Department of Development of Deposits and Mining, National university of water and environmental engineering, Rivne, Ukraine

FEATURES GAS CONTENT AND PRODUCTION OF COAL BED METHANE IN THE LVIV-VOLYN COAL BASIN

In coal basins are considerable amounts of gas, which at 80-98% consists of pure methane. There are also hydrogen sulfide, carbon monoxide and others. World reserves of methane in coal seams exceed natural gas reserves in traditional deposits. Within the coal basins located in the territories of China, Russia, the USA, Australia, Ukraine, Poland, South Africa, India, Germany, methane reserves amount to over 260 trillion cubic meters [1]. Ukraine is among the

five countries rich in coal methane reserves. However, today in Ukraine extraction and utilization of coal methane is at the level of the side activity of some mines, although the first steps in this direction were made in the 30's of the last century.

In Ukraine there are two coal basins: Donetsk (Donbass), which concentrated 92% of coal reserves Ukraine, and Lviv-Volyn - 8% of coal reserves.

The Lviv-Volyn Carboniferous Basin is located in the western part of Ukraine, in the middle course of the river Zahidniy Bug.

The area of the basin is occupied by the northwestern part of Lviv and the southwestern part of Volyn oblast. In the west, the carboniferous basin continues on the territory of Poland, which is called the Lublin Basin.

The total area of the pool is about 10 000 km² [2].

According to the territorial membership, features of the geological structure and coal formation, the degree of exploration and development in the basin distinguishes three coal mining regions: Novovolynsk, Chervonograd and South-West. Coal-bearing deposits belong to the lower and middle strata of carbon, which is concentrated to 60 coal seam thickness of 0,5-1 m.

Geological resources of coal make up 2,1 billion tons, balance reserves - more than 1,0 billion tons. Coal of two grades: G - 92% D - 8%. Depths of deposits of coal seams - 300-650 m [2, 4, 5].

A significant number of pool mines have a high risk of developing coal seams in relation to unexpected, sudden emissions of gas and coal. This leads to explosions and fires in mining, so the issue of industrial coal mining methane is relevant not only from the economic side, but also from the security side of the work of miners [3, 4, 5].

At present, there are two methods of mining coal methane: mine, that is, directly from the mines, when the air is continuously ventilated by mines, coal gas enters the surface with its subsequent separation from the air; extraction of methane from coal seams, by drilling of special wells from the surface of the surface.

The mine method of obtaining gas from coal is included in the process of coal production, because due to the extraction of methane from mining, the goal is achieved - reducing its concentration in the mine, which is a preventive measure to prevent the explosion of methane.

Extraction of methane from coal seams by drilling of special wells can become quite significant in Ukraine for the supply of methane as a fuel for industrial enterprises.

In addition to the traditional world, there are new technologies of production of gases. Due to the almost horizontal deposition of coal seams of the Lviv-Volyn basin at shallow depths, the principles of the American technology for the extraction of shale gas by horizontal wells may be based on one of the promising methods.

References

1 Орлов О.О. Геологічні особливості розвідки і розробки покладів вугільного газу / Розвідка та розробка нафтових і газових родовищ. 2011. № 3(40) – Режим доступу до ресурсу: <https://core.ac.uk/download/pdf/84122381.pdf>.

2. Маланчук З.Р. Заєць В.В., Васильчук О.Ю. Перспективні методи розробки покладів вугілля у Львівсько-Волинському регіоні / Актуальные научные исследования в современном мире: сб. научных трудов. - Переяслав-Хмельницький, 2018. – Вып. 3(35). – С. 189-193

3. Malanchuk Z., Zaiets V., Vasylychuk O., Novak A. Current status and problems of new technologies for coal mining in the western region Ukraine. Resources and resource-saving technologies in mineral mining and processing. Multi-authored monograph. – Petroșani, Romania: UNIVERSITAS Publishing, 2018. – P. 54-77.

4. Маланчук, З. Р. та Заєць, В. В. та Сольвар, Л. М. та Романчук, С. С. Підземна газифікація покладів вугілля / Вісник Національного університету водного господарства та природокористування, 2016. – Вып. 2(74). – С. 107-114.

5. Маланчук, З. Р. та Заєць, В. В. та Сольвар, Л. М. та Романчук, С. С. Методи перетворення вугілля в газоподібний носій на місці залягання / Вісник Національного університету водного господарства та природокористування, 2016. – Вып. 2(74). – С. 115-124.

UDC 622.27

L. A. KRUPNIK, Doctor of Engineering Science, professor, K. I. Satpaev Kazakh National Technical University, Republic of Kazakhstan.

YU. N. SHAPOSHNIK, Doctor of Engineering Science, leading research associate, N.A. Chinakal Institute of Mining, Siberian Branch, Russia Academy of Sciences, Russia

S. N. SHAPOSHNIK, Doctor of Engineering Science, professor, D. Serikbaev East-Kazakhstan State Technical University, Republic of Kazakhstan

THE SUBSTANTIATION OF SAFETY TECHNOLOGY OF ORE EXCAVATION IN PROTECTIVE PILLARS IN SUZDAL DEPOSIT

The Suzdal gold field is presented by three ore zones: 1–3, 2 and 4, with the sizes along the strike 900, 800 and 600 m, and the depth of mineralization 470, 300 and 320 m, respectively. The ore zone 4 is situated at the distance of 900 m from the ore zones 1-3 and 2.

The ore zone 2 is situated 500 m north-west from the zone 1-3, traced by workings along the strike to 1200 m, along the dip - 300-400 m, the dip is south-east (40-45°). This zone is characterized by complex morphology, determined by sharp crimps, swellings, frequent transition of a thick ore vein into several thin veins, rock waste windows; the height of the zone is about 40 m. The zone is accompanied by numerous thin dykes of granite-porphyrines and aplites.

The strength properties of rocks and their stability vary within wide limits.

The existing and designed surface and underground structures of Suzdal mine Alel finance and investment company are situated out of the shear zone, with the exception of the operating lift hoist 1, vent raises 1,2,3 and 9 in the ore zones 1-3, 2 and 4.

Currently the mining company has faced with the necessity of excavating ore in the protective pillars to replenish the reserves. The in-place ore reserves in the pillars are about 415 th. tonnes.

The guarded object while ore excavation in the protective pillar of block no. 3 in the line of cross-sections 8+25÷12+50 of the ore zone

2 on the level +120 m - 0 m is the vent raise no. 2.

The ore reserves in the protective pillar of the vent raise no. 2 are about 218 th. tonnes with gold content of 6.9 g/t.

The protective pillar is made with angular displacement 65° and the width of the safety berm on the level +220 m -10 m (for II protection category).

The forecast of rock-bump hazard of rock mass areas by core diskings was carried out on the basis of methodological instructive regulations by VNIMI.

According to the results of instrumental and visual studies, carried out in the Suzdal mine, it was concluded that the mine workings on the level +120 m -0 m were un Hazardous.

According to RQD, the ores and the enclosing rocks refer to medium stable. The areas of intensive crushing of rocks are located mainly on the pinching areas of the ore bodies.

On the basis of graphical plotting it was established that the area of hazardous displacements in lentils within the boundaries of the protective pillar is placed at quite a safe distance from the vent raise no. 2. Therefore, stoping will not have a significant influence on the stability of rock exposures in the area of the vent raise no. 2. However, while the development of lentil no. 101 in the cross-section 10+75 the area of hazardous displacements is aligned with the vent raise no. 2. While the development of lentil no. 101 in the cross-section 10+50 the area of hazardous displacements is situated in close vicinity to the vent raise no. 2, what does not provide the required safety of mining operations. To provide safe development of lentil no. 101 it is necessary to leave in the protective pillar ore reserves on the levels 110 m - 120 m в the cross-sections 10+75 and 10+50, which is about 2.5 th. tonnes of ore.

On the basis of calculated geometrical parameters of sublevel room-and-pillar mining with backfilling, the following design parameters of rooms were assumed: the room height is equal to the height of the sublevel- 20 m and 13,3 m, the room width is equal to ore width $m=1,5-8,0$ m, $m_{cp}=4.5$ m; the length of the room: for stable rocks -25-30 m at the depth of development $H=300$ m, for medium stable rocks -20-25 m at $H=300$ m.

On the basis of calculated geometrical parameters of sublevel

room-and-pillar mining the following design parameters of rooms were assigned: in the conditions of stable and medium stable rocks with the rock-hardness ratio $f=9-11$ (according to M.M. Protodyakonov scale) and the height of the room $h_{np}=36,5-36,0$ m (the level height -40 m, the width of the bottom and the crown pillar -3,5-4,0 m) the design limiting span of rock exposure of the hanging wall of dip room h_n is $h_n = 37,5-38,5$ m and $l_n=44,0-51,5$ m. At the level height of 40 m it is recommended to apply the average value $h_n=36,0-36,5$ m and $l_n=25,0-3,0$ m by technology factor.

At the increase of ore excavation intensity in rooms in 1,5-2,0 times the room length can be enlarged by 20-25%.

The relation between the developed area of the protective pillar of the vent raise no. 2 and its overall area is 1,77% in total. Consequently, the development of ore reserves in the pillar of the vent raise no. 2 will not have any negative effect on the safety of the protected object.

It is also recommended to backfill the voids with waste rock. At the ore density $\gamma_p=2,7$ t/m³ the volume of marked ore (the formed voids) will be about 80 th. m³. With regard to the rock contraction coefficient, equal to 1,2, the required volume of backfill will be 97 th. m³.

The comparative technical and economic assessment of the scenarios of protective measures showed that the development of ore reserves in the protective pillar of the vent raise no. 2 with regard to additional expenditure on providing mine safety is profitable.

The additional expenditures on providing safe working conditions include designing and design solution expertise, the construction of observation stations on the levels +120 m and 0 m, drilling of relief holes, backfilling.

Thus, the authors of the article provided the substantiation of safe pilot mining of the ore reserves in block no. 3 in the line of the cross-sections 8+25÷12+50 of the ore zone 2 on the level +120 m -0 m in the Suzdal mine, designed safety measures for the protected object, namely the vent raise no. 2, from harmful effect of underground mining, determined by the displacement and deformation of rocks and ground, the stoping technique in the protective pillar.

UDC 438

K. SKRZYPKOWSKI, assistant professor, AGH University of Science and Technology, Faculty of Mining and Geoengineering, Poland

W. KORZENIOWSKI, professor, AGH University of Science and Technology, Faculty of Mining and Geoengineering, Poland

K. ZAGÓRSKI, assistant professor, AGH University of Science and Technology, Faculty of Mechanical Engineering and Robotics, Poland

DIAMETERS OF BOLTING HOLES FOR UNDERGROUND MINES IN THE AREA OF LEGNICA- GŁOGÓW COPPER BELT

The paper presents different diameters of bolting holes, depending on geological conditions for underground copper mines in the Legnica-Głogów Copper Belt.

For installation of bolt support, self-propelled carriages with an internal combustion drive and with electro-hydraulic drive of the working system are used.

Nowadays an increasing challenge is to adjust the height of the machines to the thickness of the deposit being exploited. In the fields with a thickness of up to 1.7 m, machines with a height of 1,4 m are used, while in thicker deposits, machines with a height of 1,7-1,8 m and 2,3-2,5 m are used.

The roof bolters are built as self-propelled units on a two-part tire chassis. The elements of the bolting rigs are connected by a pivot joint. The working set consists of a telescopic boom, a drilling and bolting turret with a drill, and equipment for installation bolt support elements in previously made holes.

The installation of bolt supports can be done in two ways: manually or in an automatic cycle.

The roof bolters used for the installation of resin bolts are additionally equipped with devices for pneumatic setting of resin cartridges. In the case of a testing research of friction bolts, roof bolters are equipped with a special tapping block with high impact energy.

Depending on the hardness of the roof rocks and the purpose of the holes, the working systems of the roof bolters and drill rigs are equipped with hydraulic rotary-percussive or rotary drills.

Very often dry rotary drilling with a dust collection system, rotary drilling or impact drilling guarantee the effectiveness of the bolting process in all geological conditions.

Additionally automation of this process is available and increase the operator's safety with full control of the roof-bolting being done. The drilling speed is from 3 to 4 meters per minute. In the case of flooded or humid roofs, rotary drilling with water flushing is recommended.

However, for dry, concise and very compact roofs with high compressive strength (IV and V roof class) and where it is necessary to use bolting in a sandstone sidewalls, rotary-percussive drilling with water flushing is recommended.

For dry roofs, and especially in low excavations in order to maintain the intact zone of bolted rock layers, rotary drilling with suction of borings is recommended, with a recommended diameter of 25,4 mm and 28,6 mm for strong and very strong roofs.

Holes with diameters of 25,4 mm, 28,6 mm and 38 mm are designed for short bolting, i.e. up to 2.6 m long.

For longer bolts, i.e. more than 2,6 m, usually up to 7 m, holes with diameters of 28.6 mm are used (applies to bolts rods connected by a sleeve) and holes with a diameter of 51 mm (applies to cables installed in a rock mass by means of a cement binder).

Such a large hole diameter results from the fact that a plastic pipe with a diameter of 6 mm or 8 mm and a length at least equal to the length of the rope is used for venting the hole.

The cables fixed in the borehole with cementitious binder is designed to reinforce the existing excavation support, made in disturbed rocks with decreased strength, and being in areas of operational impact, as well as prone to expanding.

It is worth mentioning that the roof bolter for the mechanical installation of cable bolts is equipped with a drilling tower and a platform with an aggregate for pressing the binder into the holes.

Because the roofs of excavations in the LGOM mines are built of dolomitic rocks, which are characterized by very high compactness

and low abrasiveness index, this means that bolt holes with a diameter of 25,4 mm and 38 mm are drilled using the drill bits, armed with cutting elements made of cemented carbides, joined with a drilling rod using a threaded joint.

Borings are usually removed using a water flushing, which can reduce the strength properties of the roof rocks by penetrating the microfractures of the cracked rock mass. In addition, holes with diameters of 25.4 mm and 38 mm are also made using a rotary method using Flecher turrets, which are built on self-propelled roof bolters. They are drilled with drill bits chisels with pneumatic sucking borings.

Even in very concise dolomitic rocks, 25.4 mm diameter, drill bits allow to get the drilling progress of 3-4 meters per minute. The disadvantage of this technology is the inability to drill in a flooding rock mass. Rotary-percussive drilling of 28,6 mm and 38 mm diameter holes is performed with water flushing using column and chisel crowns.

The main advantage of this drilling technique is the ability to achieve high performance in application to sandstone rocks. It is worth mentioning that in places that are inaccessible to machines, e.g. when reconstructing the roof over conveyor belts, manual percussive drills of the WUP-22 type with pneumatic drive are used.

However, in self-propelled drilling and bolting machines, percussive drilling method is not used, because much better results are obtained during rotary and rotary-percussive drilling.

The work done as part of the statutory work of AGH: 11.11.100.005

UDC 622.817.9 (035.3)

N.A. DRIZHD, Dr. of Tech. Sciences, Prof.,

R.K. KAMAROV, Cand. of Tech. Sciences, Prof.

N.M. ZAMALIYEV, PhD, Senior Lecturer,

Karaganda State Technical University, Republic of Kazakhstan

CRITERIA OF THE NEED FOR APPLICATION OF MINE DEGASING

The release of methane into the mine workings during the underground mining of coal seams is one of the main natural factors that restrains the effective use of new mining technology and technology and significantly worsens the state of safety.

The experience of developing methane bearing coal seams at great depths shows that, without the use of degassing, the rate of penetration of workings and the load on the clearing faces is so small that they do not provide an economically viable application of modern high-performance equipment, that is why it is necessary to reduce artificially methane emissions - degassing of methane sources.

The technical feasibility of using degassing depends, on the one hand, on the geological conditions and technological parameters of the mining industry, and on the other hand, on the parameters of the methods of degassing.

The main condition for the need to implement measures for the regulation of methane emission is the excess of the amount of air required for dilution released in the clearing face of methane over the capacity of the preparation workings and the bottomhole of the clearing working faces.

The implementation of degassing measures, which are closely related to ventilation, affects not only the underground technological processes, but also, through the volume of production in the mine, also the technological complex of the surface. In carrying out these activities, the unqualified requirement is the effective balance of the system elements in order to achieve the best total effect.

The state of the system can be determined by combining three uncontrollable variables: the nature of the object of degassing - the operating section of the mine, the new section (horizon) of the

operating mine, the new designed mine; state of the object; degassing - the capacity of the mine is limited by the capacity of technological units or other factors and can not be increased; an increase in the capacity of the mine as a result of the implementation of measures for degassing (ventilation) is possible; state of ventilation - ventilation possibilities are exhausted; the load on the working face can be increased by improving the winding area.

From the analysis of the “mine” system, it follows that, under the conditions of maximum limitations of the existing section, its degassing while maintaining the total number of faces working at the mine and maintaining the capacity of the mine can only ensure a reduction in unit costs in the lava of the degassed section; in some cases there may be small changes in the cost of underground transportation and ventilation; in the newly prepared section of the existing mine or new mine with a stable number of faces and the load on the mine, in addition to reducing unit costs in the lava, the effect may be due to an increase in the speed of development workings due to improved conditions; for a new section of the existing mine that has power reserves, as well as for a new mine, the use of degassing provides the possibility of obtaining an effect within the site (increasing the load on the face due to the reduction of air supplied through it) and through the mine as a whole by increasing the concentration of mining and increasing the load on the mine.

Technological efficiency of degassing is characterized by a decrease in gas evolution, indicators of which are the coefficients of the efficiency of degassing of a separate source of gas emission, separate production or their combination (excavation section, wing, mine).

The efficiency of the degassing of a separate source is a relative decrease in gas evolution from the degassed source, equal to the ratio of the magnitude of the reduction in gas evolution from it to the amount of gas that would be released into the mine workings from the specified source in the absence of degassing. The efficiency ratio of the degassing of a separate mining (excavation section, wing, mine) is the relative decrease in gas-abundance of generation due to the use of degassing.

The relative decrease in the methane content of a degassed source is characterized by the degree of degassing - the ratio of the amount of released (recovered) gas per unit mass or volume of the degassed source to its natural methane content.

The duration of the degassing is usually determined by the mining conditions in accordance with the plan for the preparation and mining of coal. Reducing the gap in time between the end of drilling and connecting the well to the gas pipeline increases the efficiency of degassing by 10 - 12%.

At the extraction site, the accepted degassing parameters are the duration of the degassing period, the preliminary degassing factor and the initial well productivity, and the derived parameters are the distance between the wells, the length of the wells and the number of wells in the degassed field. The duration of the degassing period is determined by the mining and technical conditions in accordance with the calendar schedule for the preparation and mining of coal reserves. The coefficient of preliminary degassing is taken in dependence with the size of coal mining and the gas balance structure of the site, the vacuum depth, the gas permeability of the seam and the initial intensity of gas recovery in the well [1].

Bibliography

1. Drizhd N.A., Akhmaturov D.R. Zakharov A.M. et al. Evaluation of methane safety methods in the mines of the Karaganda basin: Monograph. - Karaganda: Publishing house of KSTU, 2016. 224 p.

UDC 622.273.132

A. MORGUN, head of technical department, PJSC “Sukha Balka”
S.CHUKHAREV, PhD (Engineering), Assoc. Prof., Kryvyi Rih
National University, Ukraine

CONCENTRATED CHARGE BLASTING IN IRON ORE MINING AT KRYVYI RIH IRON ORE BASIN

The research deals with developing and testing the technology of concentrated charge blasting with preliminarily formed shielding layers in block caving of thick iron ore deposits of Kryvyi Rih iron ore basin.

Vertical concentrated charges (VCC) have been used in Kryvyi Rih basin for mining stable and solid ores since 1980.

Specific consumption of explosives varies from 0,265 kg/t to 0,788 kg/t depending on broken ore strength. In secondary breaking, specific consumption of explosives makes 20-50 g/t as compared to 300-400 g/t of conventional breaking.

In VCC blasting, labour efficiency is two-three times higher than in long-hole blasting, sanitary and hygienic conditions are more favourable, average yield of large fractions (exceeding 30 cm) is within 7%.

Yet, for all its advantages, VCC blasting has a disadvantage which is expressed by uncontrolled back-break at depth usually equal to 0,5 of burden of hole. This can be prevented by preliminary stress-wave shielding during VCC blasting. It implies blocking out broken rock mass by shielding layers that divide it into separate blocks blasted by one or two charges. Before VCC blasting, bells are formed besides those at the VCC basement. The formed compensation chamber is a shield for reflecting explosion waves at the base of the blasted ore.

If the blasted block is destroyed by two VCCs located vertically, the upper charge is the first to detonate followed by the lower one (delayed). With thicker deposits, if two or more blasted blocks are across the strike, the ore is blasted from the hanging wall towards the footwall. Before detonating the subsequent block, the previously broken ore is drawn with the rock cushion left at the sill. Blasthole rings are drilled at the distance of 0,7 of burden of hole (W , m) off the VCC at the footwall to form shielding layers at the boundary of blasted blocks.

Concentrated charges are placed either in vertical (raise) or horizontal workings (in crown-pillar caving). To form a 6-7 m high rock cushion, about 9m^3 of rock 2×2 m in cross-section is placed at the raise opening. To reduce the amount of rock broken by the last detonation, the lower part of the raise should be driven to the height of the rock cushion with a smaller cross-section, for example, $1,2\times 1,2$ m. If the raise is driven by long-hole blasting onto the compensation chamber and long holes are not drilled into the upper working, a control long-hole is drilled from the leading working

entering the raise to control the cushion height. To place a horizontal concentrated charge (HCC), a 9 m raise is driven crossing the 3×3 m horizontal chamber of the required length.

It is recommended to use high-pressure igdanite (ИБД-5) the production technology of which is set up at the mine of the PJSC Sukha Balka.

Preliminary formation of shielding layers by detonating blasthole rings is an essential element of the VCC blasting technology.

The VCC blasting has been applied to iron ore mining at Kryvyi Rih basin for many years having proven its high efficiency. In spite of the large mass of a single charge (20-30 t and more), there are no visible damages in mine workings after VCC blasting. The crushing quality is typically higher than in long-hole blasting. Preliminary formation of shielding layers enables eliminating the increased seismic effect and out-contour damages, increasing the blasting volume by 60-70%, enhancing labour efficiency and ensuring higher quality of primary crushing.

VCC blasting with shielding layers is one of the most efficient ways to enhance underground mining of strong ores and ferruginous quartzite of Kryvyi Rih iron ore basin.

UDC 622.272

T. KALYBEKOV, Doctor of Engineering Science, Professor,
K.B. RYSBEKOV, Candidate of Technical Sciences, Associate Professor,

S.T. SOLTABAYEVA, Candidate of Technical Sciences, Associate Professor,

The Kazakh National Research Technical University after
K.I.Satpaev, Republic of Kazakhstan

THE STUDY OF THE INFLUENCE OF PREPAREDNESS OF THE ORE RESERVES ON THE PLANNING OF UNDERGROUND MINING OPERATIONS

Ensuring the effective operation of the mine and the rational use of mineral wealth is possible with the proper justification of

preparedness norms of mineral reserves for excavation during the preparation of mining operations development plan. Failure to comply with the preparedness norms of mineral raw materials reserves adopted at the mining enterprise leads to failure of the plan for the ore extraction with the required quality. Excessive preparedness of reserves affects on mining enterprise economy of due to the increase in prohibitive costs of preparing and development operations at the mine. As a result, the development of the mining plan should take into account the current state of norms of accessed, developed and blocked-out ore reserves corresponding to the mining and geological conditions of the exploited field.

When designing a plan of mining operations, the subsoil user should determine the order of reserves development, opening methods and development systems of mineral deposits, methods of capital, preparatory, first working and exploring operations [1]. At the mining enterprise, reasonable rationing of mineral reserves preparedness and optimal parameters of extraction blocks provide a rational level of completeness extraction of minerals from the subsoil.

In the plan of mining operations should be given rational volumes and timing of the following major works:

- calendar schedule of mining operations with the production volume and the required quality of minerals by the consumer;
- volumes of capital, preparatory, first working and exploring operations.

Ensuring the timely implementation of the plan of mining operations requires the settlement of the following technological solutions:

- mechanization and automation of production processes;
- measures to comply with the norms of mineral resources losses;
- preservation in the subsoil or storage of non-commercial reserves for their subsequent industrial development;
- the need for detailed and operational exploration in the ore mining process;
- geological and surveying support of mining operations;
- measures of safety of production personnel work and objects of environment from harmful influence of works;

- technical means and measures for reliable accounting of quantity and quality of extracted mineral raw materials.

Norms of prepared and ready for extraction reserves of the underground mines of the Republic, contributing to the rhythmic implementation of the mining enterprise plan and the most rational use of mineral resources reflecting technological progress and taking into account mining and geological conditions, are within 6,0-24,0 and 3,0-9,0.

Compliance with the given reasonable norms of prepared and ready-to-extraction reserves at the currently operating mining enterprises contributes to the implementation of planned productivity and even flow of mining operations with the required qualitative composition of the extracted raw materials. A significant discrepancy in the preparedness norms of reserves in the mines is the basis for clarifying their values at a particular enterprise in underground mining method.

The study of changes in the of accessed, developed and blocked-out reserves during mining shows the need to establish norms of reserves preparedness in order to ensure the rhythmic and effective deposits development [2-4]. Violation of the mining enterprise work rhythm in the implementation of the minerals extraction program can occur due to insufficient study of the patterns of changes in the volume of reserves prepared for extraction in the conduct of mining operations.

The establishment of a rational variant for the mining operations development in accordance with the number of mining equipment, the reliability of the system and the productivity of the mining enterprise facilitates the task of optimizing the volume of preparedness of reserves. In general, a reasonable ratio and comparison of normative and actual indicators of preparedness of mineral reserves ensures stable ore production at mining enterprises.

A comprehensive study of the impact of of accessed, developed and blocked-out ore reserves on the scheduling of mining operations in the development of mineral deposits by underground method in various geological and mining conditions contributes to the rational and efficient use of mineral resources with the best technical and economic indicators. Using the experience of substantiation of the reserves preparedness in the

development of existing mineral deposits eliminates the possibility of selective mining of rich and easily accessible areas at the expense of optimal planning for the mining operations development of and is essential to improve the reliability of the mining enterprise system.

The article is prepared within the project of program-targeted financing the Ministry of Education and Science of the Republic of Kazakhstan 2018/BR05235618.

References

1. Instructions for layout of mining operations plan. Order of the Minister of investment and development of the Republic of Kazakhstan dated May 18, 2018 № 351.

2. Uniform rules for the rational and complex using of mineral resources in the exploration and production of minerals. Of November 17, 2015 № 1072 and the Minister of energy of the Republic of Kazakhstan dated November 30, 2015 № 675.

3. Titov R.S. Fundamentals of the approach to optimization of reserves by the degree of their preparedness for production / Materials of the Ural mining decade. science.ursmu.ru/upload/doc/2013/05/16/geomehanika_i_geotehnologii.pdf.

4. Rakishev B.R. Rakishev E.B. Change the current stocks of rocks at the depth development system. Mountain information and analytical Bulletin. №. 1 2007. - P. 251-257. [www.ntu.kz/files/publicate / 2015-08-06-elbib _8.PDF](http://www.ntu.kz/files/publicate/2015-08-06-elbib_8.PDF) document.

UDC 005.932: [351.823: 553.04]

M. V. SHOLOKH, Cand. Sc. (Eng.), Associate Professor,
M. P. SERGIEIEVA, Senior Lecturer Kryvyi Rih National University, Ukraine

TAKING INTO ACCOUNT OF AMOUNT AND QUALITY OF ATTRACTED IN THE BOOTY OF BALANCED ON MAINTENANCE QUALITY INDEXES MINERALS OF SUPPLIES

Estimate rationality of process of mastering of mineral resources the indexes of plenitude of exception of them from the bowels of the earth and to the further processing. Especially severe losses at the primary processing of multicomponent mineral resources. Therefore, the number of «passing» components withdraws that from complex mineral raw material increases continuously. If in 1970 from the supplies of the colored and black metals withdrew 35 useful

components, in 1990 their number attained 70, then in the beginning of the XXI of century – over 80.

Researches are based on materials of work of ore mining enterprises of Krivbass. The structure of Kryvyi Rih belongs to one of the most interesting geological objects of Ukrainian of shield, that explains not only localization of bowels of the earth of unique supplies of iron-ore components but also original geological structure, history of geological development of region, that represents all basic stages of the formation.

The aim of the work is the development and introduction of methodology of determination of losses of balance-industrial supplies and impoverishment of content of quality indexes of minerals taking into account the complex mastering of bowels of the earth.

For the achievement of the aim, such tasks are untied: the analysis of present methods of determination of losses of balance-industrial supplies and impoverishment of content of quality indexes of minerals; the improvement of existent methodologies of determination of losses of balance-industrial supplies and impoverishment of content of quality indexes of minerals taking into account the complex mastering of bowels of the earth.

Today all less than one component minerals become and less than. In ferrous quartzite's except a basic component there is much copper, vanadium, zinc, lead and other useful components, part from them in composition wastes use as building material. Thus the cost of such macadam approximately equals prime prices of booty of iron-ore minerals.

On some deposits, beds, ore bodies or areas of array of ferrous quartzite's content of quality indexes of titan, vanadium, cobalt, copper, zinc, sulphur, nickel, phosphorus, germanium and non-metallic minerals sometimes higher, what in the basic deposits of minerals of the coloured metals.

The applied formulas are for determination of indexes «visible» losses of balance-industrial supplies and impoverishment of content of quality indexes of minerals in iron-ore mass both adulterations in iron-ore mass of useful components of containing breeds and their additions or reductions take into account in her due to abandonment in the losses of balance-industrial supplies of impoverished or enriched on maintenance the quality indexes of minerals of part.

However the end-point allows exactly to take into account and divide the sources of bringing in iron-ore mass on maintenance the quality indexes of useful components and source of losses of balance-industrial supplies and on maintenance quality indexes minerals of supplies, as a result visibility of prosperity is created sometimes even in case of impermissible severe losses of balance-industrial supplies.

At content of valuable component in breeds that apply, (often it arrives at 0,3–0,5 middle content of quality indexes of minerals) such visibility of prosperity is possible even at 30 % losses of balance-industrial supplies.

For example 1. In the balance-industrial supplies of ferrous quartzite's is to 32 % cities of quality indexes of iron, and at applying and containing on maintenance quality indexes minerals breeds is a 16 %.

Volume of losses of balance-industrial supplies even 30 balanced supplies, but due to producing on maintenance the quality indexes of minerals of breeds in the volume of to 30 of 100 e exception on mountain mass (that quite possible), then on a formula at content quality indexes of iron in the obtained iron-ore mass 27,2 %, what testifies to safe position, but 30 balanced supplies it is lost beyond retrieve, similarly as thrown away opportunity the use in the future presently balanced on maintenance quality indexes minerals of supplies and breeds with content of quality indexes of iron 16 And the supplies of these breeds in a pool are enormous.

For example 2. Will expect the volume of losses of balance-industrial supplies and impoverishment of content of quality indexes of minerals in iron-ore mass for the terms of the Kryvyi Rih pool, if $c=56\%$; $c_3=35\%$; $b=16\%$; $q=0,1\%$; $a=50\%$; \bar{I} =of 100 т; B =of 100 т. On the usually applied formulas the volumes of losses of balance-industrial supplies and impoverishment of content of quality indexes of minerals in iron-ore mass will present $\bar{I}=11\%$; $P=11\%$. In reality according to formulas $\bar{I}=20\%$; $P=10\%$.

If not to conduct the separate account of all sources of entering iron-ore mass from the balance-industrial supplies of useful components, then lose another possibility of objective comparison of work for the improvement of the use of bowels of the earth of areas of arrays of hard minerals that are in the different mining (at

presence of in the breeds of useful components and without them, at possibility of abandonment in the losses of balance-industrial supplies of poor on maintenance quality indexes minerals and without them) and geological conditions.

In an order to take into account this important circumstance, some other factors (even partly), for example multicomponent of minerals and possibility of determination of losses of balance-industrial supplies at the surveyor providing of booty and complexity of the use of mineral raw material, it is expedient to replace an index – content of quality indexes of useful components (metals) by next indexes:

- minerals, that withdraw the value of content of quality indexes in the balance supplies; in supplies, that loses;
- at impoverishing on maintenance quality indexes minerals breeds;
- by a value on maintenance quality indexes in digging, that withdraws.

UDK 622.272: 338.45

A.A. NAZARMATOV, the teacher,

A.A. RAHMATOV, the teacher,

M.K. SAIDOV, the teacher,

Mining-metallurgical Institute of Tajikistan, Tajikistan

ESTIMATION OF THE EFFECT OF RESOURCE-SAVING TECHNOLOGIES ON THE EFFICIENCY OF ORE MINING IN THE UNDERGROUND DEPOSIT DEVELOPMENT IN THE CONDITIONS OF THE REPUBLIC OF TAJIKISTAN

The mining industry of the Republic of Tajikistan has the specifics of a resource-oriented nature. The industrial potential of the underground mining of the Republic has a pronounced concentration at the initial stages of the technological cycle. In Tajikistan, process innovations are predominant, associated with the acquisition of equipment and aimed at improving the quality of products, i.e. preservation of the occupied place in the market.

One of the priority directions of accelerating the pace of development of this industry and solving problems of increasing the efficiency of developing a mineral deposit using an underground

method is the introduction of resource-saving technologies in production processes, as well as the development and implementation of resource-saving programs at enterprises.

Nowadays, the problems of developing and introducing resource-saving technologies at mining enterprises are becoming increasingly topical. Their early decision in a number of countries, including in Tajikistan, is considered as a strategic direction for the rational use of natural resources. The issues of resource saving and determining the optimal ratio of resources at mining enterprises are very relevant now. Financial policy in the field of resource conservation has a direct effect on the long-term state of the enterprise, as well as determines its current state. It dictates the trends of economic development, the promising level of scientific and technological progress, the state of production capacity of the enterprise.

The implementation of resource saving strategies at mining enterprises allows transferring certain types of fossil raw materials from the category of inefficient or inefficient to highly efficient, expanding and strengthening the natural resource potential of the enterprise by involving new types of mineral raw materials into industrial production and accelerating the reproduction of the mineral resource base. The use of modern resource-saving technologies should lead to a spasmodic, breakthrough effect, which makes it possible to give the economy of a country, a particular industry or enterprise a new quality of economic growth based mainly on intensive development factors.

In past years, many economists believed that the presence of rich mineral reserves contributes to the rapid growth of the economy. In recent decades, they hold a different point of view, considering the good availability of natural resources as an obstacle to successful development. As a negative point, it is noted that the growth potential of the mining sectors is relatively low. First, the reserves of natural resources are limited. Secondly, it is argued that the mining of minerals does not require high technology, so the possibility of increasing productivity in the mining sector is small.

These arguments, in our opinion, are quite controversial. Thus, specialization in the extraction of raw materials does not necessarily imply a low level of technological knowledge. With the transition to

exploitation of more complex deposits in terms of their conditions, such activity increasingly relies on the intensive use of specific high technologies. Consequently, the poor functioning of the economy can be caused not by the abundance of natural resources per se, but by inefficient ownership and control structures that have become widespread in the mineral-rich mining sectors of the countries.

It seems to us that it is the resource orientation of the economy of Tajikistan that can become the driving force of its modernization, providing the necessary funds at the initial stage. In the future, only the introduction of resource-saving technologies, allowing to introduce new, more efficient technologies, use modern mechanisms in all sectors of the economy can solve the problems of high-quality economic growth and the efficiency of using natural resources. This will allow not only more competently and fully to use the available natural resources, but also in the long term the main emphasis should be placed on their reproduction and reduction in the use of resources, especially such non-renewable resources like oil, gas and coal, a gradual transition from a raw material economy to a high-tech innovative economy based on knowledge.

In our opinion, the main obstacle in the development of innovative processes in the underground mining of minerals is the lack of connecting links in the "science-production" chain. Here, government regulation is necessary to implement the results of research and development in life.

Only on the basis of the achievements of technological transformation can we ensure the transition from traditional resource-intensive technologies to resource-saving, low-waste and waste-free technologies.

The gradual transition to the complexes of low-waste and resource-saving production, "integration of production" can significantly reduce the burden on the environment, especially at the regional level.

Modern technologies, replacing outdated and nature-intensive ones, make it possible to significantly reduce the number of fields being developed, to preserve for future generations stocks of exhaustible, non-renewable natural resources. The gigantic potential of low-waste technologies is indicated by such figures. Now, due to the imperfection of mining technologies, up to 70% of oil, 30% of coal, 20% of iron ore, etc. remain in the earth.

Thus, territorial-production complexes, with their wide possibilities for the exchange of related products and waste, closure of individual production cycles can become a promising approach to the formation of low-waste production systems. In line with this direction are measures for the reconstruction of enterprises. Replacing outdated equipment in the physical and moral plans with new, more advanced equipment allows for substantial savings in many types of resources, investments, improved product quality, etc.

It is very important that Tajikistan is already conducting research in the field of resource-saving technologies and implementing some programs in the field of introducing resource-saving technologies in mining enterprises. The development of some of our scientists could become the basis of a targeted scientific program for the development of resource-saving technologies, and in the future - a whole cluster in this area with new technologies, laboratories and specialists of a new formation.

UDC 622.817.9 (035.3)

N.A. DRIZHD, Dr. of Tech. Sciences, Prof.,

R.K. KAMAROV, Cand. of Tech. Sciences, Prof.,

N.M. ZAMALIYEV, PhD, Senior Lecturer,

Karaganda State Technical University, Republic of Kazakhstan

METHANE VOLUMES CONTAINED IN COAL SEAMS

The volumes of gases formed in the process of coalification, mainly methane, far exceeded their current content in coal - bearing strata. The methane content in coal-bearing sediments is currently determined by the existing thermodynamic conditions: temperature, gas pressure, and physicochemical properties of the rocks - porosity, permeability, humidity. Methane from coal deposits should be considered only as a passing mineral, as its extraction is technologically possible and economically rational only in the process of coal mining. Therefore, the assessment of projected industrial resources of methane in the entire area of the basins within the coal-bearing sediments currently has more theoretical than practical value.

The value of natural methane-bearing coal deposits in the CIS countries, depending on the degree of coalification of coal, increases with increasing degree of coal metamorphism and is (in m³/t) for coal: long - flame 8-10; coking fatty acids 23-28; lean 30-35; anthracocytos 40-45.

The natural methane content in coal-bearing sediments up to a depth of 1800 m is as follows: coal seams contain 20-50 % of all methane; in rocks enclosing coal seams (up to 94-99 % of the total thickness of coal - bearing strata) 50-80 %.

However, despite the fact that the methane content in the organic matter of rocks can reach 80 % of its total content in coal - bearing strata, due to the very low (close to zero) gas permeability of rocks, the methane content of rocks is not taken into account when assessing industrial resources of coal mine methane.

For the associated methane production (with minor admixtures of heavier hydrocarbons), a special technology has been developed - artificial degassing of methane sources in coal mines.

The costs of degassing operations are related to the cost of coal. Costs are usually offset by an increase in the load on the downhole, an increase in the machine time of the tunneling and mining combines, etc.

For example, when using the complex degassing method in the mines I.A. Kostenko, T. Kuzembaeva, Saranskaya CD JSC "ArcelorMittal Temirtau" with efficiency of 50-70 %, the cost of coal production decreased by 18-34 %, and the average load on the face increased by 20-40 %.

Despite the large reserves of methane in gas-bearing coal seams, its extraction by the technological methods that are used for the production of natural gas is practically impossible. This is explained by the fact that the relationship of methane with coal in coal deposits has a completely different character than the relationship of natural gas with gas - bearing rock. The difference lies in the fact that gases in natural gas fields are in a free state under high pressure in cracks, pores and voids of rocks, and the main part of gases contained in coal seams is in a sorbed state.

The main component of the free gases of coal - bearing fields is methane, but the content of methane homologs, in contrast to gas adsorbed by coal, in free gas can reach more than 5 % (for example, in the United States).

In addition, carbon dioxide and nitrogen are a constant impurity of free gas, and sometimes also hydrogen, hydrogen and inert gases. However, usually free gas accumulations in coal basins contain mostly (80-90 %) methane.

In the coal basins in the gas deposits of free gas there are small deposits with gas reserves ranging from 5 million m³ to 2 billion m³. For comparison, let us give a classification of accumulations of natural gas, which are divided into: small - with reserves of less than 10 billion m³ of gas; medium - with reserves of 10-30 billion m³ of gas; large - with reserves from 30 to 500 billion m³ of gas; unique - with reserves of more than 500 billion m³ of gas.

When considering coal mine methane as an additional mineral, the forms of methane content in the coal stratum and their volumes should be considered.

Degassing of coal mines has proven to be an effective means of artificially reducing the intensity and volume of explosive mine gas emissions in mining operations. The use of degassing significantly improves the use of high - performance tunneling and mining equipment, provides increased productivity of labor. On the other hand, when using mine degassing, methane - air mixtures are obtained that are suitable for use in the national economy.

However, the main purpose of degassing is to increase the safety and comfort of the working conditions of underground miners due to a significant artificial reduction of methane emissions in mine workings.

The use of shaftless degassing methods for coal - bearing sediments (for example, vertically directed wells drilled from the surface) is, along with a decrease in the volumes of methane content in the subsurface strata, an efficient method for producing methane.

The experience of using degassing shows that with properly selected parameters of complex degassing, it is possible to capture up to 70 - % of all methane, i.e. to achieve a degassing efficiency ratio of 0,7-0,9 [1].

Bibliography

1. Drizhd N.A., Akhmaturov D.R. Zakharov A.M. et al. Evaluation of methane safety methods in the mines of the Karaganda basin: Monograph. - Karaganda: Publishing house of KSTU, 2016. 224 p.

UDC 622.27

L. A. KRUPNIK, Doctor of Engineering Science, professor,
K. I. Satpaev Kazakh National Technical University, Republic of
Kazakhstan

Yu. N. SHAPOSHNIK, Doctor of Engineering Science, leading
research associate, N.A. Chinakal Institute of Mining, Siberian
Branch, Russia Academy of Sciences, Russia

S. N. SHAPOSHNIK, Doctor of Engineering Science, professor, D.
Serikbaev East-Kazakhstan State Technical University, Republic of
Kazakhstan

THE SUBSTANTIATION OF PARAMETERS OF THE BARRIER PILLAR BETWEEN THE OPEN PIT BOTTOM AND STOPING VOIDS IN TERMS OF THE SUZDAL MINE

The Suzdal mine is located in East Kazakhstan Province of the Republic of Kazakhstan 55 km southwest of the city of Semey.

The enclosing rocks of the minefield are presented by calcareous rocks with a thin interlayer of carbonaceous siltstones. Rocks with different slope angles are relatively stable. The enclosing rocks in fault zone are presented by mineralized limestones of various jointing and orientation, and are referred to unstable and medium stable rocks.

Ore reserves of 2C1 block in the east of the ore zone 1-3, which make by category C_1+C_2 about 200 000 t at gold content of 7,8 g/t, are located under the bottom of inactive open pit mine.

According to the plan, on the floor of the open pit mine above the ore bodies of 2C1 block there is a compressor unit, a telpher unit, a room where miners are assigned a task for their shift, and a garage. Besides, next to the constructions, there supposed to be a parking lot and a core storage. Consequently, mining under the floor of the open pit is possible only after the formation of a barrier pillar of the required thickness, which will guarantee complete safety for people, buildings and constructions in the open pit, and will also prevent uncontrollable rock fall (sink, downwarping, etc.) or movement of the ground surface and caving of the underworked rock mass.

The analysis of references and operational experience of mining companies in similar conditions showed that the assumed thickness of a rock sheet, which protects open pit bottom and benches from harmful effect of underground openings, such as sink and downwarping, can be quite different and makes: 25-15 m for Murantau open pit, 30-40 m for Gaisky copper-nickel deposit, 30 m for Rasvumchorr apatite-nepheline deposit, 25 m for 'Aikhal' mine, 13 m for Sheregesh iron-ore deposit, 35 m for Dal'negorsky deposit.

The average capacity of the ore bodies in 2C1 block of Suzdal mine is 2,2 m; the dip - 65-70°; the length of the ore bodies along a strike - 254-107 m, on the level 264 – 58 m. While the development of 2C1 block, the adjacent low-power small-sized ore bodies - lenses 47, 48, 49, 50 are included into the stoping.

The development of the eastern part of the ore zone 1-3 on the level 164-264 m is carried out by undercut-and-fill.

The problem of defining safety parameters of a barrier pillar under open pit bottom can be solved by carrying out calculations under the following conditions:

1. Maximum height of the natural roof arch. The thickness of the safety pillar is defined on the basis of the conditions of protecting open pit bottom and benches from the harmful effect of underground openings, such as funneling and notching. In this case, the parameters of the crown pillar are estimated by 'dome of natural equilibrium'.

2. The moment of deflection in a thick rigidly restrained plate.

3. Maximum mass of explosive charge, seismically safe for maintaining the pillar between the open pit bottom and underground working.

4. Considering the displacement and caving of rocks while underground mining using caving methods.

As a result of calculations for the conditions under consideration h_{bp} was 14,7 m.

Under normal development of caving zone above the worked-out area of the upper levels, a floor pillar (in our case—the barrier pillar) should be calculated in terms of three types of acting loads: compressive loads from the side of the hanging and bottom walls, shearing along the interface of the pillar with the enclosing rocks, and the loads which cause bending of the floor pillar and the development of tension stresses in decks.

The obtained results give evidence of the fact, that the calculated value of the barrier pillar thickness, which is 22 m, satisfies the condition of the pillar strength shearing along the interface of the pillar with the embedding rocks.

The thickness of the barrier pillar by maximum mass of the charge BB in terms of Suzdal mine is $H=17,38$ m.

On the basis of graphical plotting the region boundaries of hazardous displacements were defined for ore bodies in the east of the ore zone 1-3 on the cross-sections within the limits of 2C1 block while the development of blind ore deposits of restricted sizes (considering displacements and rock caving while underground mining using caving systems) by the procedure of VNIMI.

It was found out that safety mining of the ore bodies in 2C1 block using caving system within the limits of the barrier pillar required either the formation of the ore pillar of desired sizes (leaving a part of ore reserves), or the excavation of ore reserves using backfilling systems with solidifying backfill.

After the estimation of rock exposure stability while the development of the chambers of 2C1 block in middle-stable rocks whose hardness according to Protod'yakonov scale was $f=8-10$, the

width of the camber was equal to the thickness of the ore body ($m_{\max}=9,87$ m), the accepted chamber height was 40 m.

Thus, as a result of calculations the value of the barrier pillar thickness between the open pit bottom and underground workings was defined. It was equal to 22 m. Consequently, the upper boundary of a mine section while developing the reserves on the east of 2C1 block should be on the level 252 m.

It is reasonable to control geomechanical state of the barrier pillar using observation stations arranged in mine openings (roadways) of 252 m level and in specially driven across the strike of the ore body access cross-cuts.

UDC 622.016

Ye.Z. MALANCHUK, Doctor of technical sciences, professor

A.O. KHRYSTYUK, Ph. D, associate professor

V.N. ZAGOROVSKII, student

Department of Automation and Computer Integrated Systems,
National university of water and environmental engineering, Rivne,
Ukraine

FEATURES OF CONTROL OF THE HYDROMECHANICAL AMBER EXTRACTION PROCESS

Today amber extraction requires new technologies and improvement of technical and technological means to intensify the production process at which the higher productivity and efficiency and reduce the negative environmental impact on the environment. The most rational way of implementing hydroextraction of amber that does not require costly exploration and remediation, characterized by minimal capital and operating expenses, and has a prospect of improvement by controlling the speed of the ascent of amber sand deposits change in air flow and frequency fluctuations of the working body.

The process of amber extraction with using of technology of hydromechanical mining takes place after the next stages:

raising of amber on a surface by using of vibrohydraulic intensifier by means of vibration, serve of water and air;

collection of heaved up amber with the epiphase of sandy environment and loading of him on a transport vehicle by means of loading technique (loader, power-shovel, dragshovel);

transporting of the collected amber is by means of tipper to the line of enriching and sorting;

enriching and sorting of the got mass (dissociating the amber of sand and sorting it).

Essence of the offered flowsheet consists in that an array is saturated by water and activates by mechanical excitation (vibroexcitation) to formation of continuous suspended layer of such closeness, at that there is lifting force that lifts amber on the surface of deposit.

The synthesis of modern control system for mining of minerals requires establishing structural connections between the entry and initial parameters of object, correct choice of the controlled parameters and managing influences. Analysing the results of researches we set that basic regulative parameters at the hydromechanical mining of amber is an expense of water and air, frequency and amplitude of vibrations of worker, managed is a closeness of amber containing environment and speed of emerging of amber.

Coordination of work of hydromechanical complex of amber mining is provided by controller's service the tasks of direct management of operations depend upon that : the centralized management separate productive areas and objects; control of technological process of booty and transporting of amber, and also states of separate responsible knots, adjusting (in case of necessity) of processes by the controlled from distance change of options of regulators that carry out stabilizing of serve of working agents : the centralized account of amount of the got product, material and power charges and other

During realization of basic technological process (actually to the booty) stabilizing of parameters of working agents must be provided. To that end on pipelines regulative valves and diaphragms are set.

For modern control system by enterprises a characteristic tendency is to diminishing to the volume of information that acts on controller's point, during maximal local automation of objects. On controller's point of extractive complex of amber information of two types acts:

information about factors that have a clean productive value (about work or outage of aggregates, pumps, compressors and other), and also given, necessary for a calculation (to the volume of booty, expense of working agents, time of work of setting, amount and quality of the got product, expense of electric power, charges on materials and other);

given, on safety of conduct of works and emergency information.

On the basis of analysis of results of experimental researches we are work out the flow diagram of intercommunications of basic technological parameters, that allows to intensify the process of booty of amber to 95% from general supplies due to the exception of shallow factions first.

For comparison, use of existing on the enterprise of SE "UkrBurshtyn" technologies, provides the exception of amber from 40 to 60 % from kept reserves, considerable losses useful to the component explained by the use of hand labour and imperfection of technology.

Implementation of control based on the calculation of optimal air flow, depending on the geometric and physical properties of the deposit and the material to be extracted, taking into account the frequency of oscillation of the working body, using the improved method of calculating the technological parameters of amber extraction from sandy deposits hydromechanical way, will allow to provide a minimum duration of impact on the array and reduce energy consumption and water consumption of extraction technology.

In accordance with the considered materials, for providing of quality process of process control of hydromechanical exception of amber it is necessary to provide the high-fidelity measuring of parameters of expense of agents, frequency of mechanical vibrations and closeness of the got environment. In addition it is needed to provide the reliable technical equipments of providing of change of expense of water and air and also facilities of mechanical influence on a sandy environment.

References

1. Malanchuk Z., Malanchuk E., Khrystyuk A. Mathematical modeling of hydraulic mining from placer deposits of minerals / Mining of Mineral Deposits. National mining university, 2016. № 10. pp. 18–24. DOI: <http://dx.doi.org/10.15407/mining10.02.013>

2. Malanchuk Z., Malanchuk E., Khrystyuk A. Results of experimental studies of amber extraction by hydromechanical method in Ukraine / Eastern-European

Journal of Enterprise Technologies, – 2016. Vol 3, №10(81). pp. 24–28. DOI: 10.15587/1729-4061.2016.72404

3. Malanchuk Z. Results of experimental studies of amber extraction by hydromechanical method in Ukraine / [Z. Malanchuk, V Korniyenko, Y. Malanchuk and other.]. // EasternEuropean Journal of Enterprise Technologies. – 2016. – pp. 24–28. DOI: <https://doi.org/10.15587/1729-4061.2016.72404>.

4. Маланчук Є. З., Христюк А. О. Математичне моделювання процесів свердловинного гідровидобутку розсіпних корисних копалин / Вісник Інженерної академії наук. Київ, 2015. Вип. № 4. С. 187–194.

5. Malanchuk Z. R. Results of studies on amber extraction by hydromechanical method / Z. R. Malanchuk, V. Ya. Kornienko, E. Z. Malanchuk. Mining of Mineral Deposits, 11(1), 2017, 93-99. DOI: <http://doi.org/10.15407/mining11.01.093>.

6. Malanchuk Z., Korniyenko V. Modern condition and prospects of extraction of amber in Ukraine / Proceedings of the 1st International Academic Congress “Fundamental and Applied Studies in the Pacific and Atlantic Oceans Countries”. (Japan, Tokyo, 25 October 2014). Volume II. “Tokyo University Press”. – 2014. – P. 318–321.

7. Промислові технології видобутку бурштину. Монографія. / Булат А.Ф., Надугий В.П., Маланчук Е.З., Маланчук З.Р., Корнієнко В.Я./ Рівне. Вид. СПД, Дніпро. - Рівне: 2017. - 237с. ISBN 978-617-7328-43-7

UDC 622.2

O.L. SHEPEL, PhD (Engineering), Associate Professor
Kryvyi Rih National University, Ukraine

CONCERNING A DEFINITION QUESTION CONDITIONS OF AN ORE DRAWING, WHICH PROMOTE IMPROVEMENT TECHNOLOGIES OF MINING OF ORE DEPOSITS SYSTEMS OF A SUBLEVEL CAVING OF ORE

Thanks to practical data of mining of ore deposits, it is known, that an ore is drawing – one of the important operations of mining methods floor and a sublevel caving on which depend, both qualitative, and quantitative results of extraction. Therefore, improvement of technologies of working of deposits which provide improvement of parameters of an ore drawing is an actual scientific and technical problem.

The lowest losses and dilution will turn out at horizontal contact of a surface of the brought down ore to lowered barings, the minimum distance between exits of cone raises on an undercut level and a uniform ore drawing from all hatches. However practically to

create such conditions for release it is possible seldom, owing to difficulty of their simultaneous performance and consequently the question usually should be solved compromise by [1].

Release on all area of the block at horizontal contact between ore and settling soils and absence of a strong rock pressure on development workings below an undercut level usually happens, let us assume, under following conditions: 1) at the small area of deposits developed by one block; 2) at an extraction of blocks cut in a cranch or ore and soils (in such conditions half of blocks in chessboard order their extractions is developed, and also a part of blocks and at their consecutive extraction; 3) in some cases at an extraction of blocks only one lateral face, adjoining a goaf, in particular it can be admissible at moderate power of a deposit with the vertical or very abrupt pitch angle, lying in more or less steady adjoining rocks and developed blocks the in width on all power; 4) at an extraction of blocks and the several sides adjoining a goaf, but at small their horizontal sizes.

Usually on development workings simultaneous release is made for pressure decrease on a part of the area of the block at inclined contact between ore and soils. The size of a corner of an inclination changes within $30 - 70^\circ$, but on the average prevails $45 - 60^\circ$. With increase in this corner of an inclination pressure upon development workings goes down, but simultaneously with it losses and ore dilution increase. The ore drawing is made in regular intervals from all working cone raises and whenever possible in small amounts that the contact surface between ore and soil remained more or less equal.

The maximum area of release is defined by a horizontal projection of a surface of contact between ore and soils at its distribution to an undercut level.

The analysis of experiences shows, that the increase in a corner of an inclination of a surface of contact (especially more than 50°) negatively influences release indicators: the volume of pure ore extracted prior to the beginning of dilution decreases, and the volume of added barren rocks increases [2].

Caving systems show the greatest losses and ore dilution. The least losses and dilution happen at development of blocks in a cranch thanks to release of the most part of ore without contact with soils

which cave in also to their small size, and at its termination owing to horizontal contact of ore to soils.

The lowest qualitative and quantitative results of extraction are given by an extraction of blocks several lateral faces adjoining a goaf, on contact with which regular losses and dilution, from the beginning and till the end of release having the much bigger value, rather than taking place on contact to soils covering from above turn out.

Application of ways of preparation of blocks and choice of mining methods basically depends from natural (power, a pitch angle, an ore hardness and adjacent strata, technical (the applied equipment) and technological (parameters of blocks) factors.

Cost of carrying out preparatory and access roads makes a considerable part of the cost price on mining method (from 33,0% to 56,2 %). In spite of the fact that from preparatory and access roads 5–10% of pure ore are extracted only, labour input of development workings occupies one of the main places, in general more than labour expenses on sublevel caving mining method.

The accepted way and preparation order, location and section of developments should correspond to following requirements: 1) to answer modern lines of development of technology of conducting mining operations; 2) to provide timely preparation of levels and blocks for preservation of a constant reserve of the reserves of ore prepared and ready to an extraction; 3) to promote a rock pressure decrease on developments within panel; 4) to lead to reduction of expenses on fastening and its repair; 5) to provide the maximum concentration of mining operations and intensive working of reserves of the block; 6) to increase productivity of stope; 7) to reduce labour input on drivages; 8) to provide on system as a whole the minimum cost price of 1 ton of the extracted ore; 9) to plan possibility of application of the high-efficiency chisel, loading and transport equipment; 10) to reduce ore losses in earth entrails; 11) to meet the requirements of sanitary-and-hygienic conditions, safety of conducting preparatory and coal-face works.

One of conformity a variant to these requirements is without the whole scheme of preparation of the blocks, which widespread. Possibility for working of thick deposits in the conditions of a high

rock pressure at an intensive actual mining of panels and secondary use of preparatory orts is the important advantage of a way [3].

So, optimum parameters of the block at sublevel caving system [4] are such which provide the greatest possible extraction of pure ore prior to the beginning of dilution, the minimum expenses for a developments and the minimum production cost of 1 ton of ore.

References

1. Kovshulya A.A. Decrease of losses of rich ores Kryvyi Rih mining basin iron. Publishing house Academy of sciences of Ukraine the Soviet Socialist Republic, Kiev, 1962.
2. Malakhov G.M Theory and ore drawing practice / Malakhov G.M, Bezuh R.V, Petrenko P.D. – M: Entrails, 1968. – 311 p.
3. Stupnik N.I. Improvement of indicators of extraction of ore at sublevel caving system / N.I Stupnik, V.A. Kalinichenko, O.Y. Hivrenko [etc.] // The collection of scientific operations of the State enterprise "Research ore mining institute". – Kryvyi Rih: NDGRI, 2011. – № 53. – pp. 136–142.
4. Efremov V.S., etc. Preparation of blocks at mining of ore deposits. – M: Entrails, 1974. – 208 p.

UDC 622.817.4: 547.279

N.A. DRIZHD, Dr. of Tech. Sciences, Prof.

R.K. KAMAROV, Cand. of Tech. Sciences, Prof.,

N.M. ZAMALIYEV, PhD, Senior Lecturer,

Karaganda State Technical University, Republic of Kazakhstan

TECHNOLOGY PERFECTION FOR SUPPRESSION OF SULFUR - CONTAINING GAS AT UNDERGROUND MINING WORKS

In the Karaganda basin, the release of sulfur - containing gases was observed in the mines V.I. Lenina, "Molodezhnaya", "Tentekskaya", "Kazakhstanskaya", "Shakhtinskaya", "Abayskaya", T. Kuzembaeva and other mines. The release of these gases is confined to the seam D₆ - of the Dolinskaya suite and to the seams K₁₆, K₁₂ and K₁₀ - of the Karaganda suite.

The concentration of toxic gases in the mine atmosphere and their harmful effects on the human body can be reduced by taking the

following measures: reducing the duration of the work shift from 6 to 4 hours; restriction of workers' stay on the air stream emanating from the lava up to 2 hours.

People may stay on the outgoing jet 10 to 15 minutes after the removal of coal chips; use of goggles and dust masks; alternate work of two combine operators in mining shifts; reduction of the working face.

In order to create safe working conditions in the mines of the Karaganda basin, known methods were tested: neutralizing them at the spraying sites of soda ash solutions with wetting agents, calcium oxide hydrate solutions (slaked lime), coating the recovered and transported coal with technical soda with foam, creating water curtains etc.

Their use did not give positive results due to the large volumes of the emitted gases.

Scientists of Karaganda State Technical University have developed new, more effective ways to control sulfur-containing gases in clearing and preparatory workings: a method of cleaning the mine atmosphere from sulfur - containing gases, including spraying an aqueous solution of glycerol ($C_3H_8O_3$) at a concentration of 5 % to 10 %, adsorbing sulfur - containing gases and improving the sanitary and hygienic working conditions of miners; composition for treatment of gas-bearing rocks containing hydrogen sulfide, including alkali metal oxide hydrate (0,1-0,2%), triethylene glycol ($H(OCH_2CH_2)_3OH$) (0,5-1,0 %) and water, improving the sanitary and hygienic working conditions of miners due to the neutralization and adsorption of hydrogen sulfide; the way to combat sulfur-containing gases in the conduct of sewage treatment works in coal mines, including spraying an aqueous solution of glycerin (0,8-1,0 %) in the emitting zone of gases and pretreating the coal mass with liquid nitrogen by injecting it into wells that improve hygiene conditions labor of miners due to the adsorption of sulfur - containing gases and the conversion of poisonous gases into a liquid or solid state; composition for cleaning the mine atmosphere from sulfur - containing gases, including glycerin (0,5-3,0 %), alkali metal hydroxide (0,1-0,2 %) and water, which increase the cleaning efficiency of the mine atmosphere due to adsorption and

neutralization of poisonous gases; method of cleaning the mine atmosphere from sulfur - containing gases, including spraying in the zone of gases emission of an aqueous solution of fatty acid (0,5-1,0 %), caustic sodium (0,1-0,3 %), sodium carbonate (0,1-1,0), sodium chloride (11-12 %) and water, which improve the hygienic working conditions of miners due to the physicochemical effect on toxic [1].

When spraying the solution in the working atmosphere, and especially in the working area of the combine's cutting bodies, sulfur - containing gases are contacted with a solution of glycerin, which results in the complete adsorption of sulfur - containing gases.

The flow rate of the solution depends on the volume of gases released into the atmosphere of the mine workings.

The use of an aqueous solution of glycerol at the "Kazakhstanskaya" mine at the "Karagandacoal" PA when mining eastern lava 134 - D₆ - 2V with a hydrogen sulfide zone of 440-550 m allowed reducing the hydrogen sulfide content in workplaces by 7 - 9 times, which contributed to the improvement of miners hygiene and sanitary conditions, increasing the load on the lava in 2,5 times [1].

Hydroxide - glycerin composition for cleaning the mine atmosphere from hydrogen sulphide was introduced at the "Kazakhstanskaya" mine when mining lavas 254 - D₆ - 2B and 284 - D₆ - 1V.

The content of hydrogen sulfide in the face of lavas 254 - D₆ - 2V and 284 - D₆ - 1V exceeded the permissible standards of the Safety Rules 30 - 100 times or more.

The increased content of hydrogen sulfide poisonous gas in the mine air led to a significant decrease in labor productivity due to deterioration of the general physical and psychological condition of miners, as well as to frequent stops of the combine, to the loss of coal production.

Solutions of glycerol with caustic soda were fed to the cutting zone of coal, which is the most intense source of hydrogen sulfide and sulfur dioxide release. The solution was supplied using a DSU -

4 metering device through the irrigation system of a shearer 1 GSh - 68.

The use of an aqueous solution of glycerol in a concentration (0,8-1,0 %), sodium hydroxide (0,1 %) in places of intensive release of poisonous gases allowed reducing the hydrogen sulfide content in workplaces by 10-14 times, ensuring a high feed rate of the combine and intensive coal extraction in the clearing face, which contributed to the improvement of sanitary and hygienic working conditions of miners, increasing the load on the lava 1,8-2,5 times [1].

Bibliography

1. Drizhd N.A., Kamarov R.K., Isabek T.K. et al. Physico-chemical effects on sulfur-containing gases in the conduct of underground mining: Monograph. - Karaganda: Publishing house of KSTU, 2013. 186 p.

UDC 622.2-047.74:622.3

M. V. SHOLOKH, Cand. Sc. (Eng.), Associate Professor
Kryvyi Rih National University, Ukraine

PLANNING OF DEVELOPMENT OF MOUNTAIN WORKS IN THE PROCESS OF EXPLOITATION OF BALANCE- INDUSTRIAL SUPPLIES

Investigational provision of extractive power-shovels industrially-balance supplies with the different degree of preparedness to the booty and quarry overall depends on a time domain between loosening of array of ferrous quartzite's. Forming each of single streams of iron-ore mass it takes place under act of losses of balance-industrial supplies and obstruction of content of quality indexes of minerals in the stream of iron-ore mass.

Therefore, taking into account influence of losses of balance-industrial supplies and the obstruction of content of quality indexes of minerals in the stream of iron-ore mass execute calculations of signs of content of quality indexes of minerals in the single streams of iron-ore mass. Base the decision of these task expressions of balance of amount

of iron-ore mass and amount of content of quality indexes of the iron related to magnetite at working off areas of deposits of hard minerals.

Productive work of every extractive unit at the booty of ferrous quartzites arrive at an open method, if certain accordance sticks to between the different project technological types of mountain works. Planning of development of mountain works in the process of exploitation of balance-industrial supplies of areas of array of hard minerals of deposit is the important stage in the decision of questions of technology of mountain production that provides plenitude of mastering of balance supplies of bowels of the earth.

At the annual planning of development of mountain works go into detail and specify perspective plans, and also decide concrete technological questions: establishment of volumes of pre-production mining and threaded works taking into account norms on the degree of preparedness of the prepared and ready to the booty balance-industrial supplies exposed, and also task on the volume of commodity products; set experience works that is sent to the improvement of booty of balance-industrial supplies from the bowels of the earth; determine the rational amount of simultaneously working extractive units with the aim of providing of necessary amount and quality of commodity products; set the optimal loading, fold the calendar graphic arts of booty of balance-industrial supplies of ferrous quartzites on every extractive unit and determine terms their redemption.

Provision of every extractive power-shovel the industrially-balance supplies prepared to the booty with the different degree of preparedness to the booty, and quarry on the whole, depends on a time domain between loosening of array of ferrous quartzites. Effective work of quarry will be in that case, when time domains between the mass loosening of array of balance-industrial supplies and loosening of array of ferrous quartzites in coalfaces gather, then, when time of mass explosion coincides in all extractive coalfaces. An optimal time domain between the mass loosening of array of balance-industrial supplies in iron-ore careers is in limits from two to three weeks.

An aim of work is development of methodology of setting of norms of ready of the booty of balance-industrial supplies. For the

achievement of the aim such tasks are untied: it is an analysis of present methods of setting of norms of ready to boot of balance-industrial supplies; it is an improvement of existent methodologies of setting of norms of the balance-industrial supplies prepared to the booty; it is establishment of norms of the balance-industrial supplies prepared to the booty.

Methodology of optimization preparedness to the booty of balance-industrial supplies and system of content of quality indexes of minerals in the stream of iron-ore mass at the open method of booty in comparing to underground, at general methodical approach, has substantial differences.

Firstly extractive unit at the underground method of booty keeps balance reserves that determine the parameters of the accepted system of development, and optimization of preparedness to the booty of balance-industrial supplies is optimization of number of extractive units.

Secondly on careers ready to the booty, the prepared and exposed industrially-balance supplies change in wide limits at the same number of extractive power-shovels.

There is a task to optimization of not only number of extractive power-shovels but also their provision of the industrially-balance supplies prepared to the booty and in addition, at an open method in the process of averaging out of content of quality indexes of minerals in the stream of iron-ore mass of value has direction of mining on extractive ledges.

If at the underground method of booty, optimizing the system characterize a presence two independent changeable are numbers of extractive units on an ore-mining enterprise and capacity of composition of averaging out of content of quality indexes of minerals in iron-ore mass, then at the open method of booty of balance-industrial supplies to these two add changeable two is a provision of the industrially-balance supplies prepared to the booty and direction of mining.

Optimization at four and mathematical vehicle let to untie such task.

However for realization number of independent changeable expediently and it maybe to shorten.

Create the industrially-balance changeable is difficult and bulky, but will be carried out, so as the worked out methodology supplies

prepared to the booty on a career with the aim of providing of the productivity of extractive power-shovels.

Determine necessary front of works of one extractive power-shovel under right technological planning of enterprises, that is why size balance-industrial supplies that provide one extractive power-shovel prepared to the booty, determine coming from his productivity and normative front of extractive works.

If the examine the provision of quarry the industrial supplies prepared to the booty as dependent changeable, conditioned by the number of extractive units, in connection with it independent changeable during optimization will shorten to three: number of extractive units; direction of booty of balance-industrial supplies; a volume of composition of averaging out of content of quality indexes of minerals is in iron-ore mass.

Optimization of balance-industrial supplies after the degree of preparedness to the booty together with the system of averaging out content of quality indexes of minerals in the stream of iron-ore mass carry out separately for every category of balance-industrial supplies and for all categories simultaneously.

UDC 622.01.18

V.Ya. OSENNIY, M.S (Tech),

N.V. OSENNYAYA, M.S (Tech),

Institute of the Geotechnical Mechanics of National Science Academy of Ukraine, Ukraine

O.V. KHOLIIVIK, Ph.D. (Tech), Associate Professor,
National Technical University of Ukraine “Igor Sikorsky Kyiv Polytechnic Institute”

ABOUT RESOURCE-SAVING TECHNOLOGIES OF DEVELOPMENT OF MAGNETITE QUARTZITES

The most important characteristics of XXI century specialists are the global of thinking, the ability to analyze huge information flows, and the readiness for creative solutions to problems. The processes of

globalization turn education into an important element of the social infrastructure of developed countries and the requirements for professional activities of an engineer are changing, the content of which is filled with social humanitarian sense and becomes an integral part of fundamental engineering training.

The problem of social-humanitarian training of engineers is not studied enough. Today, an engineer must learn to assess the social and cultural consequences of professional activity and master the philosophical problems of technology, which requires the implementation of a new concept of engineering education and an understanding of the social-cultural foundations of engineering, engineering creativity and environmental problems.

Improving the process of extracting magnetotitic ores is associated with the solution of environmental problems. A number of studies have shown the possibility of solving environmental aspects using plasma-capping and well expansion [1–4].

The prospect of creating resource-saving technologies for the extraction of magnetite ores based on the use of boiler cavities obtained by the plasma method for placing explosives used in Kryvbas. Under drilling conditions of the mines, when developing magnetite ores, mechanical drilling machines make it possible to obtain wells of the same diameter along their entire length and create charging cavities in the form of cylinders.

At the wellhead diameter and the diameter of the charging cavity are the same. With the increase in the diameter of the wells that require hard rock, decreases the efficiency of the explosion. More effective is the combined technology of drilling blocks of magnetite quartzites: drilling small diameter wells with machine tools along an expanded grid and then expanding them with plasma trons in the necessary places to create charging cavities.

This technology makes it possible to reduce the volume of drilling operations and effectively manage the explosion process. The diameter of each cavity can be 3-6 times the diameter of the pioneer wells. Such a form of the charging cavity creates an effect of locking the wellhead and allows for more efficient blasting.

It becomes possible to disperse the charges in the rock mass in such a way that the destruction of magnetite ores occurs due to shear

and tensile stresses. The use of elongated charges of explosives with boiler extensions allows us to improve the efficiency of the explosion by controlling the energy emitted into the mountain massif [1].

The study of the stress-strain state of the iron ore massif in the vicinity of a borehole obtained by the plasma method at various angles to the ore body is of great importance in the development of hard ore deposits. Industrial tests of plasma-caulking plants and the expansion of wells, as well as the development of new technologies for breaking strong ores in Kryvbass showed that it is difficult to obtain information in the zone of thermal destruction of rocks [2].

In the mechanics of a deformable body, research on linear fracture mechanics has been developed, investigating the development of cracks in perfectly elastic bodies. Fundamental aspects in this area (theory, models, criteria) are characterized by validity and logical completeness. Less studied questions of the mechanics of the destruction of rocks. The theoretical substantiation of the plasma torch energy transfer to the well wall (in the monitoring of the developing boiler cavity) was partially reflected in [3].

The relevance of research into the formation of thermal stresses in solids is due to the appearance of applied problems describing the effect of low-temperature plasma on rocks in various mining and technological processes. To establish the quantitative parameters of the specific processes of formation of thermal stresses in the mountain range, in monitoring the development of the boiler cavity was used optically — the polarization method, which allowed varying the magnitude of external force influences simulating mountain pressure in a wide area.

This is due to the fact that most of the works on thermal destruction of rocks did not take into account the commensurability of power loads and the parameters of thermal stresses from a heating source, the values of heating rate and rock pressure. Studies of the formation of total stresses from power and thermal loads on the bottom hole made it possible to establish that heat accumulates (localizes) in the prefecture zone, which requires changing the modes of the plasma torch [4].

The creation of environmentally friendly technologies for the destruction of magnetite quartzite implies that researchers have a high professional and creative potential, the scale of engineering thinking and an understanding of the socio-cultural foundations of technology and scientific and technical creativity.

Referenctc

1. Osenniy V.Ya. O kotlovoj polosti i racional'noj konstrukcii zarjada pri otbojke krepkih rud v podzemnyh uslovijah / V.Ya. Osenniy, N.V. Osenniyaya // IX Mizhnarodna naukovno-tehnichna konferencija «Rozrobka, vikoristannja ta ekologichna bezpeka suchasnih granul'ovanih ta emul'sijnih vibuhovih rechovin»: Materiali konferencii, Kremenchuk – Svaljava, 04-09 February 2013. – Kremenchuk : KrNU, 2013. – P. 39-41.

2. Osenniy V.Ya. Tehnika i tehnologiya oburivaniya blokov magnetitovyh kvarcitolov s primeneniem plazmotronov v podzemnyh uslovijah rudnikov Krivbassa / V.Ya. Osenniy // USIV. – 2014. - № 2. – P. 14-20.

3. Makeyev S.Yu., Osenniy V.Ya., Ryzhov G.A., Osenniyaya., Holyavik O.V. Theoretical consideration of plasma energy transfer to the rock mass // Geotekhnicheskaya mehanika. – 2016. – Vyp. 128. – P. 139-148.

4. Osinniy V.Ya. Robochiy organ girnichoj mashini na osnovi niz'koterperaturnoj plazmi / V.Ya. Osinniy // II Mizhnarodnaya naukovno-tehnichnaj internet-konferencija «Innovacijnij rozvitok girnichodobuvnoj galuzi». – 2017. – P. 319.

UDC 622.831.2

M.V. PETLOVANYI,

V.V. RUSKYKH,

K.S. SAI, PhD (Engineering), Associate Professor,
Dnipro University of Technology, Ukraine

CHALLENGES OF UNDERGROUND MINING OF STEEPLY PITCHING DEPOSITS WITH STOWING IN ANOMALOUS GEOLOGICAL ENVIRONMENT

Annually, Ukraine mines almost 75-80 tons of iron ore; moreover, 9 mines extract almost 15 mln tons using under-ground method. Chamber mining and sublevel caving (Kryvyi Rih iron ore deposit) [1]. However, chamber mining with hardening stowing has already been practiced by PJSC “Zaporizkyi Zalizoorudnyi

Kombinat” (PJSC “ZZK”). The method provides both stability and gradual increase in output during long period of time. PJSC “ZZK” mining high-grade iron ore of Bilozirka iron-ore district, extracts significant share (i.e. 25%) of Ukrainian ore recovery using underground method. Implementation of the mining system with hardening stowing by PJSC “ZZK” made it possible to achieve more qualitative extraction indices to compare with iron ore mining without stowing in Kryvorizhzhia. Indices of ore losses and its dilution are 2-2,3 times less [2]. However, despite the system efficiency, severe problems concerning stability of hanging wall enclosing rocks as well as stowing rock mass arose at the depth of 640-940 m. The problems are stipulated by rock pressure and intensified seismic impact of blasting operations resulting in mined ore degradation and reduced performance indicators on the whole. Caving of hanging wall rocks factors into the following: increase in the mined-out area to be stowed; ore degradation and increase in its prime cost; problems connected with iron-ore product grade control in the context of stopes; and decreased safety of development mine workings within hanging wall of the deposit [3]. To identify reasons of reduced stability of natural rock mass and man-made one, it is necessary to analyze mineralogical composition, geological structure, and mode of occurrence of both ore deposit and enclosing rocks.

In terms of horizontal plane of ore deposit as well as in terms of its depth, structure and mineral composition of enclosing rocks along with inclination angle and bedding angle differ greatly. The deposit is a ribbon of ferruginous quartzites in-curved westerly (north westerly-north eastwardly) under total submeridional strike of ferruginous quartzites containing high-grade iron ores. The strike is north westerly (310°) within southern wing; starting from central part, the strike varies its direction to northeast (40°). The same situation is with inclination angle of the ore deposit; it increases its

value from south (60-65°) to north (80-85°). Analysis of changes, taking place in geological structure and mode of occurrence in the strike and in the ore deposit depth, made it possible to identify common tendency of the decreased hardness of hanging wall rocks and inclination angle of the deposit; changes in morphological structure of rock from northern wing to southern one; and increased thickness of the deposit. Ore rock mass and enclosing rocks demonstrate intensive fissuring as well as frequent substitution of rocks with variable hardness characteristics within process parameters of stopes [4]. Faults are not available; however, opening of certain fissures is either in vertical planes or in gently inclined ones with 10-20° slope angles within the whole territory of the deposit. Strike of vertical fissures prevails towards 350°; strike of gently inclined ones prevails towards 250-275°. Fissure density varies from low fracturing (i.e. up to 2 fissures per meter) to rather heavy one (i.e. 20 fissures per meter). Moreover, the ore body deepening results in the increased zone of unstable low-hard quartz-chlorite-sericite shales within rocks of southern wing. It is 60 m at 400 m depth; 150 m at 640 m depth; 330 m at 740 m depth; and 600 m at 840 m depth.

When 640 – 740 m level was mined, values of ore dilution in chambers, extracted within a contact with hanging wall rocks, achieved sometimes 8%; they were 12% at 740 – 840 m level. It should be noted that often cavings of hanging wall rocks are observed within central and southern parts of the deposit with 550 m length. 70% and more inrushes take place within the sites in the context of all the level chambers. At central and southern sites, where inrushes happen frequently, the deposit curves; strike angle and inclination angle vary as well as morphological composition and rock properties. The fact affords ground to designate the site as transition zone where various characteristics of the ore deposit

enclosing rocks cross. When the deposits sites, where rocks of hanging wall diluted chambers, and changes in geological factors along the ore deposit were compared, it has been determined that concentration of hanging wall rocks experiences its intensification when ferruginous quartzites are substituted by quartz-chlorite-sericite shales; when hardness and stability of enclosing rocks of hanging wall reduce; when inclination of ore deposit decreases; and when thickness of the ore deposit increases and dilution indices significantly as well.

Hence, complex geological and tectonic structure of ore deposit; significant changes in its strike and inclination, in rock hardness, in the ore deposit thickness from western wing to southern one; availability of folding of the ore and rock boundary form anomalous geological environment where gravitation acts on stopes take a new form differing from classic theories and concepts. Iron ore mining under anomalous geological conditions should be based upon innovative scientific approach concerning provision of rock mass stability depending upon a system of the involved mining and geological factors.

Analysis of features concerning ore deposit mining under complex mining and geological conditions makes it possible to insist that such conditions needs scientific substantiation of a mechanism to form load within hanging wall of the deposit on stopes located in a zone of drastic changes in natural environment. Consideration of the aspects will help lay basis for optimization of the order of the reserves mining within the deposit area; parameters of the system to mine and break ore reserves in stopes under varying mining and geological conditions.

References

1. Ступник, Н.И., & Письменный, С.В. (2012). Перспективные технологические варианты дальнейшей отработки железорудных месторождений системами с массовым обрушением руды. *Вісник Криворізького Національного Університету*, (30), 3-6.
2. Khomenko, O., Kononenko, M., & Petlyovanyy, M. (2014). Investigation of stress-strain state of rock massif around the secondary chambers. *Progressive Technologies of Coal, Coalbed Methane, and Ores Mining*, 241-245. <https://doi.org/10.1201/b17547-43>
3. Urli, V., & Esmaili, K. (2016). A stability-economic model for an open stope to prevent dilution using the ore-skin design. *International Journal of Rock Mechanics and Mining Sciences*, (82), 71-82. <https://doi.org/10.1016/j.ijrmms.2015.12.001>
4. Kuzmenko, O., & Petlovanyi, M. (2017). Interrelation of structural changes of the enclosing massif with sustainability of extraction chamber during iron ore deposit development. *Journal of Donetsk Mining Institute*, (2), 56-61. <https://doi.org/10.31474/1999-981x-2017-2-56-61>.

Section “Open pit Mining”

UDK 622.235

A.A. SKACHKOV, mining engineer, Acting Director General,
PJSC «Northern Mining and Processing Enterprise», Ukraine

S.A. ZHUKOV, Doctor of Sciences (Engineering), professor,

D.A. TITOV, student, Kryvyi Rih National University, Ukraine

SYMMETRIC BLASTING OF ROCKS IN CONDITIONS OF OPEN PIT WITH NARROW WORKING FIELDS

Scientific research to the effectiveness of Blasting and Explosion Works (BEW) in the open pits, the problem of the unevenness of the granulometric composition of the blasted rock, as well as the excessively high cost and environmental aggressiveness of this process clearly indicates that this problem is not completely solved.

The least investigated theoretically and unresolved virtually question of BEW is the uneven formation under the action of an explosion of a strained-deformed state of rock masses of a complex regular structure with acoustic anisotropy caused by it, which predominantly has a periodic functional dependence (epicycloidal) of elastic-mechanical characteristics relative to the spatial orientation of structural dominants of rocks. The increasing effectiveness of blasting can be possible by differentiating the strain of the massif, optimizing the interaction between the borehole charges with the massif and between each other, and also improving the BEW technology, in particular – the methods of creating actually working additional reflective elastic waves of slits and structures of charges for this. In connection with this, the idea was laid for the use of a preliminary reflection slit for the formation of an additional reflective crack in the acoustically anisotropic rock massif of spatially complex forms of surfaces of various stressed states, as well as the intensification of the differential strain of the massif by explosion at the expense of specially designed multi-type charges *E*. To solve this problem, the research provided justification for the optimal forms of rock destruction zones around charges of

explosives and the mutual arrangement of the mentioned one in the explosive network, when the charges of the first series of the boreholes (main relieving charges) are initiated only after passing through them of the direct and reflected of the slopes of the wave tip the explosion of charges of the second row, thus creating the conditions for the symmetrical action of the basic charges between the two reflective surfaces – the vertical slope of the ledge from one, and created with the short-term "back" gap - from the other.

It is known that the decrease of the rocks crushing quality with the defined structural-regularity (system cracking and blocking effect) is determined by the formation something like a waveguide. This contradiction led the authors to the idea of finding solutions to avoid this effect by coordinating the combination of the trochoid contours of the destruction zones around the borehole charges of adjacent rows in the presence of vertical ledge of rocks and additional reflecting gaps to provide symmetric conditions work of borehole charges, purposefully designed of a combined construction.

The boreholes are grouped in 2 and exploded in sequence: 2nd→1nd→4th→3rd→6th→5th and so on. The application of vertical slopes in combination with the proposed sequence of charges blasting in grouped pairwise rows ensures the unification of borehole charges, and reduces by 5÷7% the specific cost of E .

The analysis of the BHD in relation to the open pit "Pivnichniy", where the mentioned above implementation of the differentiated-energy rocks saturation in the conditions of the dry boreholes with the simplest E - Granulite KM was carried out - showed the following. For this E , the measured values of charge density and detonation velocity are 1020 kg/m³ and 3850 m/s respectively, and the estimated heat of explosion is 980 kcal/kg. Calculated for these conditions, the value of the polytropic index (n) is 1.8, that is within the limits typical for powdered E (1,5÷2,0). The mass velocity in the Chapman-Jouguet plane $\omega=1375$ m/s, and pressure of the detonation wave $P_2=5,504 \cdot 10^8$, Pa. This pressure is twice the stationary pressure in the borehole: $P_w=5,504 \cdot 108/2=2,752 \cdot 10^8$ Pa; Since the charge length is 4 m and its diameter is 0,25 m, the area perceived by this pressure is 3,61 m². The total area of the wave from a cylindrical part and two hemispheres from the ends of the charge at the time of its release to the boundary of the crushing funnel is 267,42 m², that is in

74 times larger, than the original (3,61 m²). Taking into account the cost of energy for the rocks destruction (for example, 20%), the pressure is about 3,0 MPa. At the same time, with the approach of the wave to the roof of a ledge, the pressure will be about 0,5 MPa, and near the scarp of a ledge - even less.

At the same time, experimental explosions with the registration of real deformations and stresses in the rock massif around the charges of E revealed somewhat lower indicators than the idealized calculations. Analyzing the stress state and structure of the massif, we established the main cause of this difference - the effect of system macrogaps that divide the rock massif into separate blocks. And after performing a comparative analysis of the values of the above mentioned deviations with the values of the gaps opening, they developed a simplified method of compensating for it in calculations by introducing the corresponding coefficient K_{st} , which differs from the known in that, it takes into account not only the level of filling gaps with mineral smalls, but also the kinetics of the explosion and the inertial factor of passing an elastic wave through a macrogap. The physical meaning of this coefficient is in the "stepped" cutting of the amplitude of the elastic wave when it is extended through the blocks or layers of the rock, in combination with plastic deformations of near-surface zones of macrogaps caused by the movement of rock masses when considering the behavior of the collapses rock massif as a set of elastic rods.

Introduction of this coefficient significantly improves the convergence of theoretical calculations and experimental records for the determination of the interaction of explosion energy with the rock massif. Accordingly, the boundaries of the zones of minimum and maximum loads of a block rock massif are proposed to be determined not by a theoretical but by a modified trochoid.

Conclusions. Taking into account the results of research analysis, the authors are currently focused experiments to the multiplication of the exploded groups in the same sequence of well charges. At the same time, other vertical gaps are created, but already along the flanks of the exploding block. Certain combinations of methods and parameters of mass explosions confirm the feasibility of continuing research in this direction. However, today the number of industrial experiments is still insufficient for final conclusions, therefore, another 15 experimental explosions are planned for the next year.

S.G. ONIKA, Doctor of Science (Engineering), Professor,
E.J. NARYZHNOVA, Senior Lecturer, Belarusian National
 Technical University, the Republic of Belarus

SEISMICALLY SAFE PARAMETERS OF EXPLOSIONS IN A QUARRY OF NATURAL STONE

With the technology of charge explosions applied at quarries with a millisecond delay, the total explosion energy is divided into separate parts and is transmitted to the surroundings in which it is also distributed in separate parts. As a result, the maximum fluctuations at a certain point or region of the protected object are not determined by the entire mass of the explosive, but only by its part exploding at the deceleration stage, i.e. mass charge per step of deceleration. This fact is experimentally confirmed on seismograms of large-scale explosions.

In a not quite obvious form, this very important, from a practical point of view, conclusion is reflected in the methodology for determining seismically safe distances given in the Unified Safety Rules for blasting of blasting works adopted in Belarus. According to the instructions of the Uniform Rules, with non-simultaneous exploding of charge explosives with a total mass with a deceleration time between explosions of each charge for at least 20 ms, the determination of safe distances is made by the formula.

$$r_c = K_r K_c \frac{\alpha}{N^{\frac{1}{4}}} Q^{\frac{1}{2}},$$

where K_r , K_c , α - empirical coefficients;

N - number of charge groups;

Q - total mass of explosives exploded.

Considering that the right-hand side of formula contains dependent values, we express, $Q = Q_{rp} N$, where Q_{rp} - the mass of the exploded explosive at the deceleration stage and present the above-mentioned formula as an equivalent expression

$$r_c = K_r K_c \alpha N^{0,08} Q_{rp}^{\frac{1}{2}}$$

From the analysis of the formula, it can be seen that the effect on the seismic effect of the actual total mass of the exploded explosive is insignificant, since with increasing the increase in the seismic safety distance occurs slowly because $N_{0.08}$ is close to one.

Considering the empirical nature of the formulas under consideration and the accuracy of seismic recording equipment, characterized by a measurement error of 10–15%, it is safe to recognize the redundancy of refinements related to the total mass of explosive charges. From the theory of errors, it follows that with a relative error in determining a seismic safety distance of 10–15%, the exponent cannot be determined with an accuracy of the 3rd digit and, taking into account the order of this number, it can be taken equal to zero. Then the seismic safety distance is independent of the total mass of the explosive charge, as evidenced by the practice of large-scale explosions in quarries.

In difficult mining conditions, the seismic safety calculation should be performed with a given reliability, which is governed by the accepted probability level for the upper value of the velocity of displacements. According to the Uniform Safety Rules for blasting works, the parameters of explosions should ensure the absence of damage with a probability of 0.1.

We have proposed a formula for determining of the seismic-safe mass of explosive charge blasting in one stage of deceleration with a given probability, which has the following form.

$$Q = [V / \exp[-\frac{2(z-\gamma^*)}{\eta}]^2 R^3,$$

when y, u - Johnson's SL-distribution form parameters;

v - permissible fluctuation rate for the protected object, cm/s;

Q - the maximum mass of the charge on the deceleration stage.

R - distance to the object, m;

With its use, on the instructions of the enterprise, the zoning of the field of a quarry of natural stone was made according to the seismically safe mass of charge per deceleration stage.

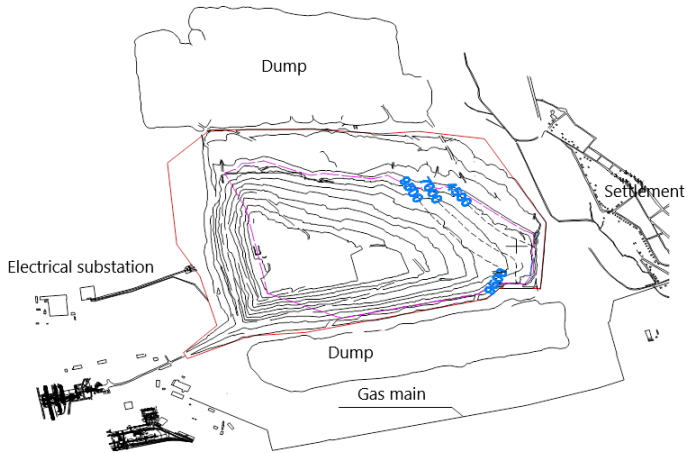

Picture. Map of permissible mass of explosive charges

The performed work makes it possible to remove restrictions on the total mass of exploded explosive and to ensure prompt assessment of the seismic safety of explosions.

UDC 622.271: 622.17: 624.137.2: 624.131.537

K. TOMICZEK, PhD (Engineering), Assistant Professor,
Silesian University of Technology, Poland

AN ATTEMPT TO DETERMINE AND VERIFY THE PROPERTIES OF A DUMP MATERIAL

Often, in geotechnical engineering practice, the designer is not aware of complete information on the properties of strength and deformation properties of the soils and rocks.

The aim of the analysis was to find the material constants of the dump material to design the embankments. It was not possible to determine them on the basis of laboratory tests.

The opencast mine is located in the Lesser Poland Voivodship. It exploits deposits of limestone, dolomite and marl. The exploitation is

carried out with simultaneous levelling, formation of slopes. Post-mining waste and rock aggregates are used for macrolevelling.

The basic tasks to determine the stability of embankments is to find potential slip surfaces and a balance of forces sliding and bonding the embankment.

It was not possible to obtain information of mining waste properties. Back analyses were performed and the values of cohesion c and internal friction angle φ were determined.

The calculations were based of Janbu, Bishop and, alternatively, Fellenius methods. RocScience's Slide v.5,0 program was used. Post-mining waste the Coulomb-Mohr criterion was assigned.

It should be stated that generally there is no information on the properties of post-mining waste published.

The reason for this problem is the coarse-grained structure nature of the material and thus difficulties in laboratory tests.

Material type	Material description	c [kPa]	φ [°]	Authors
Coal mining wastes	Gravel fraction (40÷2mm) 66%	16,0÷30,1	32,5÷32,8	(Baran et al., 2009)
Post mining materials	Depth 0÷2m Depth 2÷16m	1,8 26,8÷47,6	36,4÷45,0	(Sternik, 2011)
Post-mining waste materials	Dry Water saturated	40 12	17	(Charanpret, 2009)
Post-mining dump waste	Waste with 5% dust and clay	23	39	(Zapał, 2007)

The results of existing laboratory tests show that the cohesion c of coal waste is (however) greater than 0 (Tab.).

For back analysis the results of researches of similar coal mining waste dump in Czerwionka-Leszczyny were used.

The real angle of natural repose is approximately 50 to 60° (although it is generally assumed that the angle of natural repose φ_{rz} for loose soils is about 33° and equal to the angle of internal friction φ in very loose compaction).

If the angle of the natural repose of the embankment in Czerwionka-Leszczyny equals from 50 to 60°, it is possible to calculate the cohesion c by back analysis. Cohesion calculations for 128 different embankment models were made (Fig. 1). The angle of the natural repose φ_{rz} was equal to 40-60° and the bulk density φ was (16÷18)kN/m³.

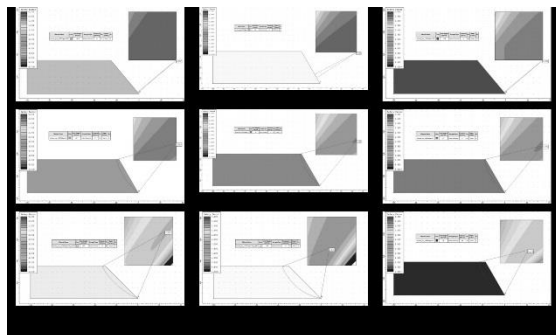

Fig. 1. Examples of back analyses for various inclination 1:m, angle of internal friction φ and cohesion c

Despite the knowledge about the properties of Czerwionka-Leszczyny mine wastes, angles of natural repose φ_{rz} equal to (as much as) 50÷60° were rejected. The c values calculated by back analysis seemed unrealistic:

- verified what values have been assumed for cohesion c for the natural repose angle of 45° with the assumed bulk volume φ ;
- cohesion values c from the lower (documented by the Author) ranges from 10 to 20kPa were taken into account.

On the basis of: literature studies, verbal information, local visions of the Czerwionka-Leszczyna embankment, comparative analyses, own experiments and back analyses, it was assumed that for mine wastes it is justifiable to assume (at least) cohesion c equal to 10kPa, angle of internal friction (computational) γ equal to 40°, bulk density γ equal to 18kN/m³ (e.g. Fig. 2 and 3).

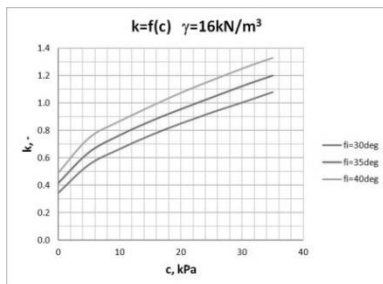

Fig. 2. Cohesion c for different (ϕ_i) and ϕ_{rz} (ϕ_{i_rz} equal to 60° ; k (F) - safety factor

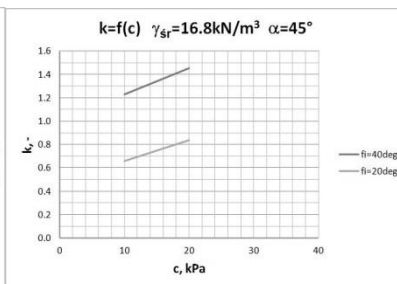

Fig. 3. Cohesion c for (ϕ_i) equal to 40° and 20° and for ϕ_{rz} (ϕ_{i_rz}) equal to 45°

The analysis takes into account the impact of compaction to which the mine waste stone will be subjected.

The analyses carried out indicated that if the density increases (and the volume weight) the safety factor k (F) (for $c = \text{const}$) about 0,1÷0,2 increases. Relatively large increase in cohesion c approximately 5kPa was observed.

The densification of the mine waste stone compaction of the embankment influences on increase in cohesion c and, as a result, the improvement of the safety factor k (F) by 0,3. Verbal information received proves that since 2014 embankments remain stability and don't slip.

References

1. Baran P., Cholewa M., Zawisza E. i Kulasik K. Problem jednoznaczego ustalenia parametrów wytrzymałości na ścinanie odpadów powęglowych i poenergetycznych. The Problem of Unequivocal Determination of the Shear Strength Parameters of Colliery Waste and Fuel Ashes. Rocznik Ochrona Środowiska, Tom 15, 2013, 2071–2089
2. Charanpreet S.F. Evaluation of slope stability for waste rock dumps in a mine. Department of Mining Engineering, National Institute of Technology, Rourkela, 2009
3. Tomiczek K. Badania wytrzymałości skał na ścinanie. Shear strength tests of rocks. Wydawnictwo Górnicze, Kwartalnik Budownictwo Górnicze i Tunelowe, nr 3, Katowice 2008, 11-20
4. Zapał A. i Ratomski J. Geotechniczna ocena przydatności odpadów kopalnianych w hydrotechnicznym budownictwie ziemnym. Geotechnical assessment of suitability of mine wastes in hydrotechnical earth structures. Czasopismo Techniczne, Wydawnictwo Politechniki Krakowskiej, z.2-Ś/2007, Kraków 2007

Keywords: surface mining, open pit mine, embankments and slopes stability, slip surface, Coulomb-Mohr criterion, cohesion, angle of internal friction

MOUSSA ZAOU, University M^{ed} Boudiaf M'sila, Algeria
CHOUKI FARSI, University M^{ed} Boudiaf M'sila, Algeria
SERHII ZHUKOV, National University of Krivoy Rog, Ukraine

EXPERIMENTAL STUDY AND NUMERICAL MODELING OF DUCTILE TEARING IN A WELDED JOINT

For a better understanding of the processes leading to the ductile tearing of welded structures, we tested two approaches to fracture mechanics: a comprehensive approach (J, CTOD) and a local approach (R/R0). The experimental study will help determine the mechanical properties and the resistance to ductile tearing at room temperature, the metal base (MB), molten metal (MF) and the heat affected zone (HAZ) taken from a solder joint made under conditions representative of industrial manufactures. Numerical modeling has highlighted the complexity of the characterization of ductile tearing in the case of welded joints. Nevertheless, this work allows us to check: 1) the influence of mechanical properties of the base metal in the case of a rate overmatching importantly, the overall behavior of such structures (the evolution of the load, the integral J, CTOD, the plastic zones); 2) the sensitivity of growth rate of cavities R/R0 any change in the fields of stress and strain at the bottom of the crack.

The yield strength in the HAZ is much higher than the yield strength in other areas of the solder joint. Regarding the tensile strength from the base metal is lower than in the other two areas. We note that all the values of yield stress and tensile strength exceeding those minimum guarantees (manufacturer data). There's usually a limit conventional and rational elasticity, higher than in the HAZ of the base metal MF was higher than the base metal.

The tests measure the resistance to ductile tearing were performed according to the method of partial discharges. The points can be made in consideration of these curves are as follows:

- a limited plastic instability occurring after the peak of the loading curve for the case of the heat affected zone (HAZ);

- presence of ductility, note the presence of a ductile bearing or the existence of a structural homogeneity, which leads to characteristics of the ductile fracture (MF);

- in (MB), it should be noted that the maximum loads reached in the various tests are virtually identical and the curves show the same general appearance. The bearing ductile load is low, or the existence of a structural homogenization.

The simulations of rupture tests implemented experimentally have been made using the code "CASTEM. The type specimen is modeled Senba (three point bending). The mesh is made with mesh Quadrilateral 8 knots for deeming the condition of plane strain (CPS8). In the crack tip, it is particularly refined approach to modeling local. The evaluation of the integral J take place on 6 contours, such as $a/w=0.5$. Finally, the regressions mesh are scheduled to avoid sudden changes in mesh size and the elements too distorted. From digital evolution of the load versus displacement imposed for different configurations we draw the following lessons:

Good agreement between numerical and experimental results is observed in the elastic portion of these curves, the difference occurs beyond the elastic range, this phenomenon is mainly related to differences in the laws of behavior of these materials.

The difference between numerical and experimental results remains very low for the base metal (monometallic MB). This validates our assumptions. The gap between the curve and that of the bimetallic monometallic (MB) is low (about 12% for $d=2$ mm). By cons for the curve and that of monometallic Trimetal (MB), it is important (about 30% for the same step).

The evolution of J integral for the three configurations (MB, MF and HAZ) calculated according. Note that the three calculations, however, give an identical boot toughness for low values of displacement, and relative changes for larger displacements. The difference in the contour integral J between the base metal and heat affected zone HAZ for $d=2$ mm is almost double, same difference was noticed between the base metal and weld metal. The evolution of integral J respectively for the monometallic, bimetallic and trimetal shows that there is a small gap between values calculated numerically and those determined experimentally. This finding

confirms previously observed trends in the curves "Force-displacement" and brought to light primarily a small difference between the curves corresponding to bimetal and trimetal.

Considering the evolution of the parameter in different configurations R/R_0 (monometallic, and Bi trimetal) according to the imposed displacement, we note that there is a similarity with the evolution of CTOD vs. displacement imposed, this configuration is also evident in the evolution of locale R/R_0 . In indeed, we notice a slight difference between the monometallic (MB) and bimetallic (about 8%), while the difference between the monometallic and is Trimetal Importers (50%). This difference shows that contrary to the integral J, the parameter R/R_0 is very sensitive to strain fields and stress at crack tip. The evolution of parameter R/R_0 in the case of monometallic (MB) is larger than that found in the case of Trimetal. This difference is due to the fact that the yield for the HAZ is higher than the base metal. In the case of bimetal R/R_0 demeure the largest. This configuration seems therefore the most dangerous, because the bottom of the crack is in direct contact with the MB.

Conclusion. This study on the tear of the carbon manganese steel (grade A48), which is based on extensive experimental database has yielded interesting results in both experimental models. This work has explored the various parameters (related to the mechanical properties of materials, geometry of the weld and specimen geometry) that occur at the same time, to explain the phenomena of ductile tearing and provide contribution to the study of the ductile tearing in a welded joint in order to develop an analytical method, adapted to this type of junction. The experimental study allowed us to experimentally determine the mechanical properties and resistance to ductile tearing at room temperature, the metal base (MB), molten metal (MF) and the heat affected zone (HAZ) taken from a weld produced in conditions representative of industrial manufactures. Numerical modeling has highlighted the complexity of the characterization of ductile tearing in the case of welded joints. Nevertheless, this work has allowed us to conclude that the growth rate of cavities R/R_0 is sensitive to changes in the fields of stresses and strains in the bottom crack. The local approach seems be a valid alternative for the study of ductile tearing in the case of welded joints. This approach requires a calculation taking into account the heterogeneity of the structure.

O.O. VUSYK, graduate student,
A.M. PYZHYYK, PhD, Assoc. Prof.
Kryvyi Rih National University, Ukraine

EXPERIENCE OF OPERATION OF MINING SURFACE MINERS THE DEVELOPMENT OF HALF-ROCKY ROCKS AND ROCKY ROCKS

The boundaries of iron ore open-pits are located close to settlements there is a need to mining rocks without the use of blasting to expand the contours of the surface of the open-pits. In iron ore open-pits is the possibility of effective use of non-blasting mining of the rock massif. Thus, non-blasting development allows you to remove more mineral reserves than when performing a mass explosion, by reducing the safe distance of open mining operations in residential areas.

One of the promising non-blasting technologies for the development of rocks is the progressive technology of surface mining of the rock massif when using mining.

Surface miners carry out surface mining of rocks providing a sufficient level of control over the size of pieces of light-mineral rocks with no output of the oversized fraction and thereby reduce the operating costs of mining and the load on mining equipment. Due to the non-blasting development of the rock massif by surface miners, there is no seismic effect of the blasting on the condition and stability of the pit walls and their elements as compared to the traditional technology when conducting a mass explosion.

Testing of the rock massif by mining harvesters is carried out by the platform, which is surface milled in succession by parallel passes along the length of the front of work according to the shuttle pattern of movement with a direct load of mineral rocks into the vehicle. For design features, the harvesters perform turns at the end of the passage to continue working out the next strip of rocks in the opposite direction or idling reverse with returning to the starting position of the next milling strip. When performing its immediate work of weakening the rock massif represented by a ledge, which the surface miner works and if necessary it can simultaneously form a transport

cross-over, this ensures the rationality of its operation in the development of iron ore deposits.

As a result of the rational use of open-pit milling machines in open-pit mining of mineral deposits, it requires solving a whole range of tasks, one related to their use in existing open-source technologies, so that they work as efficiently as possible in existing operating conditions without needing to make significant changes open source development for their implementation.

Non-blasting the development of half-rocky rocks and rocky rocks of mineral deposits is realized through the use of mining surface miners. Such high-performance mining equipment stands out against the background of other mechanical methods of preparing rocks for excavation and loading operations, due to its versatility in any working conditions due to its maneuverability, ease of maintenance, and control of the output of the fraction of pieces of the desired size of rocks, etc.

Installation and systematization of its operational parameters of the actual work is possible in the process of its work. One before interested in determining the dynamics of its performance, as well as fixing and processing the duration of all operations of the surface miner. The operations of the working cycle include: the average number of loaded dump trucks in one completed pass, the working depth of the mining of the rock massif, the volume of withdrawal of the rock massif per one working pass. Further can carry out the estimated performance of the surface miners and the number of loaded dump trucks in 1 hour.

As a result of analyzing the operating experience of the mining surface miners at mining enterprises, the following features of the use of non-blasting mining of mineral deposits can be identified: As a result of analyzing the operating experience of the surface mining miners at mining enterprises, the following features of the use of non-blasting mining of mineral deposits can be identified:

when using milling type mining combines in the development of mineral deposits in the technology of opencast development, it becomes possible to combine the basic operations of two technological processes into one, in which the rocks are prepared for excavation, their actual extraction and load;

the use of surface mining ensures the uniformity of the grain-size yield of the granulated rock of the desired size of the pieces, as well as the absence of the output of oversize;

the working site is the slaughter of a miner it easily adapts to the development of previously created elements of the mineral resource development system;

the disadvantages of using surface miners harvesters is the low productivity of performing mining at the initial stage of commissioning, since it is limited to the required dimensions of the elements of the development system, but later on the productivity is normalized to the desired value/

It is important to complete a techno-economic analysis of the technology of surface mining of the rock massif by mining combines, taking into account the coefficient of strength of rocks on the scale of M.M. Protodyakonov.

So, the analysis of the operating experience of open-pit surface mining harvesters in various conditions of the development of mineral deposits allows us to establish a new fundamental possibility of the technology of surface mining of rocks of iron ore deposits. It is also important to determine the rational regimes of surface mining by mining combines, in order to ensure the greatest efficiency in the maintenance of the no-fly technology of the development of rocks of iron ore open-pits.

UDC 622.013: 658.56: 621.929

M. V. SHOLOKH, Cand. Sc. (Eng.), Associate Professor,

V. V. KOBZAR, Student

Kryvyi Rih National University, Ukraine

INFLUENCE OF LOSSES OF BALANCE-INDUSTRIAL SUPPLIES AND OBSTRUCTION OF CONTENT OF QUALITY INDEXES OF MINERALS IS IN IRON-ORE MASS ON THE PROCESS OF AVERAGING OUT

Forming each of single streams of iron-ore mass it takes place under act of losses of balance-industrial supplies and obstruction of content of quality indexes of minerals in the stream of iron-ore mass.

Therefore, taking into account influence of losses of balance-industrial supplies and the obstruction of content of quality indexes of minerals in the stream of iron-ore mass execute calculations of signs of content of quality indexes of minerals in the single streams of iron-ore mass. Base the decision of these task expressions of balance of amount of iron-ore mass and amount of content of quality indexes of the iron related to magnetite at working off areas of deposits of hard minerals.

In relation to work of one extractive unit in a i - y change have changeable indexes of booty, losses of balance-industrial supplies, obstruction of content of quality indexes of minerals and content of quality indexes of the iron related to magnetite, what deposits set for areas, used in a i - y change. Thus examine change abilities of indexes of technological process as casual functions during the fixed period (change, ten-day period, month, quarter and other), that mean that during work of separate mining unit and all ore mining enterprise) amount and content of quality indexes of the obtained and lost balance-industrial supplies, amount of breeds of obstruction and content of quality indexes for them averaging out useful component examine as casual processes and for their description the mathematical vehicle of theory of casual functions (is used cross-correlation functions).

Formulas just for any area of minerals develop that, that is why will use them for the estimation of amount of content of quality indexes of the iron related to magnetite and to content of quality indexes of minerals in the stream of iron-ore mass, by obtained mining unit in a fixed period of time (hour, change, daytime). For example, in relation to work of one extractive unit in i - y change expressions have changeable indexes of booty, losses of balance-industrial supplies, obstruction of content of quality indexes of minerals and content of quality indexes of the iron related to magnetite that is set for the areas of bed exhaust in a i - y change. Thus change abilities of indexes et al examine as casual functions during a corresponding period (twenty-four hours, ten-day period, month, quarter and other), that mean, that during work of separate extractive unit or all ore-mining enterprises amount and content of quality indexes of obtained and the lost balance-industrial supplies, amount of breeds of obstruction and content of quality indexes for them averaging useful component examine as casual processes and for their description the mathematical vehicle of theory of casual functions is

used. In the quality indexes of descriptions of casual processes, losses of balance-industrial supplies and obstruction of content of quality indexes of minerals determine accordingly the cross-correlation functions. For determination of correlative functions of right and left parts of equality determine the presence of cross-correlation of accidental functions, that is included in expression of balance of amount of content of quality indexes of the iron related to magnetite.

Task decides taking into account cross-correlation all accidental functions of $\mathcal{D}_i, \mathcal{H}_i, \mathcal{B}_i, C_i$ and. Thus limited to consideration of characteristic case of booty of balance-industrial supplies from a deposit at that casual functions of $\mathcal{D}_i, \mathcal{H}_i, \mathcal{B}_i$ mutually correlates, and all other casual functions - does not correlate. For these terms, taking into account, that X and X' values of casual function, that attributing to the different moments of time of t and t' (to the different crossing of casual function). Expression shows, copulas between quality signs, characterize the processes of averaging-out of content of quality indexes of minerals that in iron-ore mass, losses of balance-industrial supplies and obstructions of content of quality indexes of minerals during work of separate extractive unit. In case at $t=t'$ formula will use for determination to dispersion of content of quality indexes of averaging out useful component in the obtained balance-industrial supplies. Will consider cases at the booty of balance-industrial supplies.

1. *The obstruction of content of quality indexes of minerals passes gobs.* For determination of f covariance assume that $\bar{b} = \bar{b}' = 0$, $r_{bb}=0$. For the calculations of dispersion of content of quality indexes of useful component at the obstruction of content of quality indexes of minerals assume gobs, that $\bar{b} = 0$ and $\sigma_b=0$.

2. *The obstruction of content of quality indexes of minerals is absent.* For the calculation of covariance function of content of quality indexes of useful component at this case will accept, that $\bar{B}=\bar{B}'=0$, $r_{BB'}=0$. For the calculation of dispersion assume, that $\bar{B}=0$, $\sigma_B=0$, $K_{\mathcal{D}B}=0$, $K_{\mathcal{H}B}=0$.

3. *The losses of balance-industrial supplies at booty are absent.* It means that of value of all indexes, balance-industrial supplies related to the losses from the array of hard minerals, id est $\bar{\Pi}$, \bar{c}_i , $r_{\Pi i}$, accept

such that equal a zero. Dispersion for this case will taking on all values of indexes of losses of balance-industrial supplies that equal a zero.

4. *The losses of balance-industrial supplies are absent and the obstruction of content of quality indexes of minerals in the stream of iron-ore mass passes gobs.*

In this case accept $\bar{b} = \bar{b}' = 0$, $b = b' = 0$, $r_{bb} = 0$.

Like from will get expression for the calculations of dispersion of content of quality indexes of useful component. In default of losses of balance-industrial supplies and obstruction of content of quality indexes of useful minerals, a covariance function and dispersion of content of quality indexes of averaging-out useful component in the obtained balance-industrial supplies depend only on content of quality indexes of useful component in the bowels of the earth, what confirms the justice of the set dependences.

Analyzing taking into account the terms of booty of balance-industrial supplies will execute the estimation of influence of losses of balance-industrial supplies and obstruction of content of quality indexes of minerals in the stream of iron-ore mass on homogeneity of quality composition of single stream of iron-ore mass that comes from the coalface (or coalfaces) of separate extractive unit.

Changeable in these formulas determine from geological survey data and materials of exploitation of deposit, bed, ore body or areas of array of hard minerals.

Difficulties are presented by determination of functions of $r_{BB'}$, $r_{bb'}$, $r_{III'}$, $r_{cIIc'}$ at the booty of balance-industrial supplies underground method.

UDC 622.882

T. KALYBEKOV, Dr.Tech.Sci., prof.

K.B. RYSBEKOV, Cand.Tech.Sci., ass.prof.

M.N. SANDIBEKOV, Cand.Tech.Sci., ass.prof.

of KazNRTU after K.I. Satpayev, Republic of Kazakhstan

STUDYING OF THE CONDITION OF THE MINED LANDS ON OPEN-CAST MININGS AND THEIR RECULTIVATION

Land reclamation at opencast mining of fields is the important direction of restitution of technogenic landscapes and includes works on improvement of the environmental environment. At a biological stage of recultivation are held phytomeliorative and cultural operations directed to creation of a steady vegetable cover on the surface of technogenic massifs. During lands restitution works on the disturbed sites recultivation in the course of mineral deposits development are carried out and favourable environments for the subsequent land use in this area are created.

Now in the Republic of Kazakhstan there are 248.3 thousand hectares of the technologically disturbed lands in the process of construction of the industrial facilities, the linear constructions and when mineral deposits developing [1]. In the regional plan, the greatest number of the mined lands is in three areas, in Mangystau - 78.6 thousand hectares, in Karaganda - 45.3 thousand hectares and in Kostanay - 37.8 thousand hectares. In total 3346 enterprises and the organizations having in their territory the mined lands which are obliged to arrange on their restitution according to requirements of the current legislation in the republic are registered.

On open mining operations of the Vasilkovsky gold field the area of the mined lands is 2031.3 hectares, on the Kounrad mine - 1011.31 hectares, on Nurkazgansky MPP (Mining and Processing Plant) - 477.58 hectares, on Aktogaysky MPP - 3754.65 hectares [2-5]. As a result of studying of the technologically disturbed lands condition at the mining enterprises the most rational directions of recultivation are proved: water management, sanitary and hygienic and nature protection depending on mining conditions and geographic location of a technogenic object.

On the Rodnikovoye field we studied a state and the rational direction of land reclamation with land laser scanning use and field soil examination of the mined lands when open mining operations is conducted. Laser scanning allowed obtaining the complete information on an object in a short interval of time and with the required quality that is impossible at traditional methods. Operating parameters of a dump in the plan are 65×260 meters, height is equal to 6,5 m. Scanning was made by the Leica ScanStation P40 scanner on perimeter of a dump and pit from 9 reference points with a permission density of 5-10 mm. By results of shooting the scans of point clouds, the topographical plan and digital model of a surface are received.

On technogenic landscapes of open-cast mining phytocoenosis on the mined lands according to geobotanical researches are studied. By results of geobotanical inspection of the field's territory is revealed that on the broken habitats the serdechnitsa prevails, to it also cereals and miscellaneous herbs are added, other indicators of broken condition - a Jerusalem sage and an alison also participate in herbage addition. Vegetation consists of vegetable groups of natural and ruderal flora, single bushes. Dumps of the field characterized by mosaic distribution of numerous vegetable groups. On steep slopes of the artificial plateau-like site single bushes of a meadowsweet, a karagana, a honeysuckle are meet. On the northwest bottom of the site willow bushes grow which form continuous thickets.

Results of the carried-out field studying allowed proving the principles of an artificial vegetable cover creation on the technologically disturbed lands of the mine enterprise. According to the executed researches, the conclusions that the stage of biological recultivation has to be carried out taking into account recommendations about a zone agrotechnology were drawn. At this land reclamation stage a creation of vegetable communities of decorative, greening and sanitary and hygienic appointment is provided. In addition, it is necessary to hold the additional events directed to improvement of physical properties of the created remediation layer. The importation of mineral fertilizers belongs to such actions of the recovery works production.

Acceleration of dumps overgrowing is provided with a combination of natural and artificial vegetation when carrying out recultivation with soil layer deposition on a dump surface and landing of dominant and subdominant plants with high indications of a mikosymbiosis which were defined in vitro.

The high mycotrophy of plants promotes the best adaptation and growth of plants on technogenesis.

Further these plant species are recommended for biological recultivation of the lands broken by mining operations.

As a result of studying of the technologically disturbed lands condition with use of land laser scanning and according to field soil inspections on the Rodnikovoye field the direction of broken sites recultivation is proved.

On the basis of laboratory and field geobotanical inspection of an object the sanitary and hygienic direction of biological restitution of the technologically disturbed lands at the field open-cast mining is offered.

For the purpose of formation of an artificial vegetable cover and overgrowth a soil fertile layer deposition on a dump surface by agrotechnical receptions is recommended.

Article is prepared on the GF project of Ministry of Education and Science of the Republic of Kazakhstan 2018/APO5131591.

References

1. The summary analytical status report on condition and use of the lands of the Republic of Kazakhstan for 2017. Astana, 2018.-275 pages.
2. The report on JSC Altyntau Kokshetau for 2017 Kokshetau, 2017.
3. Working draft. Reconstruction of a Kounrad pit regarding working off of east board. Almaty, 2012.-214 pages.
4. Nurkazgansky MPP. Environmental impact assessment. Zhezkazgan, 2007.-274 pages.
5. Working draft "Expansion of Aktogaysky MPP. Preparation plant for sulphidic ores". Astana, 2018.-234 pages.

S. BAJIĆ, Msc (Engineering), post-graduate,
B. GLUŠČEVIĆ, PhD (Engineering), Associate Professor,
Faculty of Mining and Geology, University of Belgrade, Serbia

ANALYSIS OF INFLUENCE OF BLASTING AT OPEN PIT MINES ON SURROUNDING BUILT OBJECTS AND ENVIRONMENT

Key words: blasting, impacts, measuring, influence, seismic

In this paper we have shown problems connected to the negative effects that refer to works when blasting is being done, as well as the conclusions in reference to the same. One of those negative effects is the occurrence of seismic activity and its influence on built objects and environment. Impacts that appear due to blasting may cause damage on built and other mining objects. These impacts have most unfavorable effect on people as well as the environment. Because of these effects certain standards have been made defining permitted influence impact values on built objects and people in buildings. In Serbia there are no standards as to how to estimate the influence of the impact. Therefore, in order to solve this problem, we will use Russian and German regulations and standards.

Measuring of blasting impacts was done at PK Ranci in the function of used quantities of explosive, their influence on the surrounding built objects, as well as the estimation of the measuring results according to the corresponding international scales.

Introduction - Ranci limestone deposit is situated north-east of Gornji Milanovac and south of Ljig. It belongs to the group of exogene deposits, sediment type. Limestone from Ranci deposit may be used as technical-building rock for the production of aggregate that is used as material in concrete production. This kind of limestone, broken and cut is used for civil engineering and building construction industry, also as rock for building of hydro-technical objects.

Criteria for the seismic effect of blasting - Elastic deformations caused by dynamic action of blasting charges represent an oscillatory process that is seismic effect of blasting. Elastic deformations appearing at the time spread in the form of elastic waves radially

from the seat of explosion. During explosion, in the working environment there appear simultaneously all kinds of elastic waves, however with the change of distance their intensity changes.

Intensity of the seismic waves may be established by measuring one of the essential dynamic parameters of the induced environment and that is: *oscillation velocity* (v), *accelerations* (a) or *soil movement* (x). Achieving the connection between these parameters is possible if one of the parameters is defined by instruments, the others may be defined by calculation. One of the most frequent parameters to be used to estimate seismic intensity is the oscillation velocity of the induced soil (v). Maximal resulting oscillation velocity of the soil (v_{\max}) is arrived at as intensity of the vector components in directions of X, Y and Z-axis.

Work on executing blasting and measuring - At PK Ranci - s. Boljkovci six blasting's were done.

Blasting's were done during exploitation of limestone, and explosive used for breaking rock mass was Riogel 60/1785; ANFO-J, packed in bags of 25,0 kg.

Quantity of explosive used for blasting was 284.17-2,437,30 kg.

Maximal quantity of explosive per one interval was: 50,71 kg, explosive was activated by nonel detonators, mark 17/6000; 17/7000; 17/8000; 17/9000 and 17/500.

Activating explosive in drills was carried out by rudnel system (dual delay).

Initiation of the tube was done by detonator powder charge no.8 and slow- burning fuse.

Instrument used for measuring impact is Vibralok.

These instruments that record are placed (dug) in the soil in front of built object at the distance of 1,0-1,5 m from foundation. In further text we be shown results of one blasting at one measuring point.

Review and evaluation of the measurement results - Evaluation of the stress intensity that occurred when blasting rock-mass and its fragmentation, as well as their influence on built and mining objects, was done on the basis of the following criteria:

Criterion per scale IFZA science Russia;

Criterion per DIN 4150;

Criterion per DIN 4150 - influence of blasting on environment.

A total of six blasting's was carried out. At 4 measuring points instruments recorded 24 results of oscillation velocity.

Seismic waves were being registered by 4 instruments.

This chapter contains the review and evaluation of the measurement results of one blasting carried out at one measuring point. For the given measuring point the following values are shown:

Distance from the center of blasting field (MP) to measuring points (MM): 321 m

Maximal quantity of explosive per one interval $Q_i = 25,920$ kg

Total quantity of explosive $Q_{uk} = 234,17$ kg

Maximal oscillation velocity per components (MM/s) $V_v = 2.013$; $V_T = 2,759$; $V_L = 1,839$

Resulting maximal oscillation velocity $V_{max} = 3,879$ mm/s

Value $KB_{fm} = 1,139$

Frequency per components $f(Hz)$ $V = 30,2$; $T = 22,3$; $L = 31,2$

Evaluation of measurement results per: IFZA (Russia) =A; per DIN (Germany) =C; per DIN (KB_{fm})=E

Conclusion - On the basis of received results that have been processed for the given blasting, as well as measurements that have been done at PK Ranci, it can be concluded that recorded oscillation velocity values in the surroundings of the open pit as regards influence on the built objects, are in the range of permitted values, *thus they have no influence on built objects.*

Also, recorded oscillation velocity values at the site where they have been located, as regards its influence on the environment, are in the range of permitted values, and that according to the scale has no influence on environment.

UDC 622.232.5

V. Ya. KORNIYENKO, Ph.D., professor,

V.V. SEMENIUK, assistant,

V. Ya. ROMANOVSKYI, postgraduate

Department of Development of Deposits and Mining, National
university of water and environmental engineering, Rivne, Ukraine

EXPLORATION OF THE EFFICIENCY OF DEVELOPMENT OF AMBER DEPOSITS IN A COMBINED METHOD

In Ukraine, considerable deposits of amber have been explored. Rivne region accounts for about six percent of the world's stock of amber. At present, the main stocks of amber-succinate of Ukraine are found in the right-bank part of Polissya - the Pripyat Amber Basin (the northern part of the Volyn, Rivne, Zhytomyr and Kyiv oblasts). There were 44 amber deposits and a couple of fields: Klesivske, Vlina, and others. The total reserves are estimated at 100 thousand tons, which predominate in sandy and sandy-clay soils at depths up to 15 meters and are sufficient for research and introduction of new technologies and equipment [1; 2].

Extraction of amber from sand deposits is mainly carried out in two methods: mechanical and hydraulic. The mechanical method involves the mechanical development of an array of soil in an open quarry or underground, and includes: the disclosure of the productive soil layer, excavation work, rock breeding, rocketing, rock washing, land reclamation. The hydraulic method is carried out by blurring the productive soil layer with high pressure jets, and by removing amber to the surface of the deposit by hydraulic flows. The method is accompanied by the removal of mineral soil to the surface of the deposit, does not ensure the complete removal of amber from the deposits, energy-intensive, leads to changes in the structure of soils, the formation of cavities. Therefore, these problems need to be disrupted by the fact that mechanisms and machines used for known methods of amber extraction (mechanical and hydraulic) damage the environment, destroying the natural landscape, and also does not completely remove the valuable component from the massifs [3; 4].

Amber has applications in various industries. It is easy to cut, polished and polished, with a wide range of colors. The main

direction of the use of amber is the jewelry industry, products of its chemical processing in the medical and chemical industries are widely used. In the jewelry industry, amber fractions of large and medium size are used to make jewelry. In medicine, amber acid is used. In order to get it, amber is crushed into powder. For this purpose, even the smallest grains of this stone will suit, which usually remains in the soil after the development of amber deposits by mechanical or hydraulic methods, are suitable [5; 6].

The combined method includes a number of technological operations involving different machinery. This method includes layered development of amber massifs with the use of excavators, dump trucks, scrapers and sifters. With the help of excavators, the top layer of soil is removed, where the bulk of the valuable component is concentrated, loaded into the dump truck and sent to the sloop process. At this stage, larger fractions remain on the sieve and are sent to the next stage of processing (washing, sorting by fractions, color, storage), and sand with smaller fractions that passed through the sieve of the screen, is sent to the washing in special water tanks. In them, the concentrate is slowly stirred, so that the smallest grains of amber are washed, expelled and selected for further processing, and the precipitate is sent to the settling tank. Water from the settling tank is sent to the recycling process, and the sand is stored in the produced place of the open-cast. Also, with a combination of excavators, scrapers can be used on the lower places. The process of extracting amber with the use of scrapers is similar to the use of excavators. First, remove layers of layer of soil containing amber and send it to the process of sifting and flushing. Thus, there is a process of full "sifting" of the deposit containing amber from its surface and to the sole of the career, during which the amber is completely removed from the massif.

To reduce the cost of transportation of rock containing the amber and empty rock, which passed all stages of enrichment can be used conveyors. At these stages of development and processing arrays containing amber while progress reclamation. After all, in the developed space of the open-cast is already empty rock [7].

In the combined method, the complete removal of amber and its placers (the smallest fractions) from the sand massif. So, the size of mined minerals is increased in comparison with known methods, the

income of the enterprise increases. At the same time, the process of re-cultivation of used land takes place, which reduces the costs for the enterprise and this land is more likely to be returned to use in the national economy.

References

1. Маланчук З.Р., Корнієнко В.Я., Маланчук Е.З. Результати досліджень видобутку бурштину гідромеханічним способом / *Mining of Mineral Deposits.* – 11(1). – 2017. – Р. 93–99. – Режим доступу до ресурсу: <http://doi.org/10.15407/mining.11.01.093>.

2. Results of experimental studies of amber extraction by hydromechanical method in Ukraine. Malanchuk Z., Korniyenko V., Malanchuk E., Khrysyuk A. *Eastern-European Journal of Enterprise Technologies*, v.3. № 10(81). 2016. P. 24–28. – DOI: 10.15587/1729-4061.2016.72404.u 2015 04518 від 08.05.2015. – Київ, 2015. – Бюл. № 22.

3. Спосіб видобутку бурштину. Пат. № 120504 Україна. МПК⁹ E21C 45/00 / Маланчук З. Р., Маланчук С. З., Корнієнко В. Я., Христюк А. О., Загорівський В. Н., Ковальчук Ю. Т. // ДСІВ України. – Заявл. у 2017 03320 від 06.04.2017. – Київ, 2017. – Бюл. № 21.

4. Спосіб з видобування бурштину. Пат. № 120248 Україна. МПК⁹ B03B 5/00, B03B 5/12, B03B 5/28, B03B 5/30 / Надутий В. П., Маланчук З. Р., Корнієнко В. Я., Чолишкіна В. В. // ДСІВ України. – Заявл. у 2017 04378 від 03.05.2017. – Київ, 2017. – Бюл. № 20.

5. Z. Malanchuk, V. Moshynskyi, Y. Malanchuk, V. Korniyenko. *Physico-Mechanical and Chemical Characteristics of Amber. Non-Traditional Technologies in the Mining Industry.* Trans Tech Publications Inc. *Solid State Phenomena* (Volume 277), 2018, pp. 80-89 doi: <https://doi.org/10.4028/www.scientific.net/SSP.277>

6. Malanchuk Z.R., Malanchuk E.Z., Korniyenko V. Ya. Modern geotechnical methods of management of the process of amber extraction / Multi-authored monograph: "Innovative development of resource-saving technologies of mining of minerals" Publishing house «St. Ivan Rilsky» Mining and Mining University of Geology (Sofia, Bulgaria). – 2018. – P.80–103.

7. Рекультивация порушенных земель внаслідок незаконного видобутку бурштину. Корнієнко В. Я., Маланчук С. З., Волк П. П., Васильчук О. Ю., Семенов В. В. Актуальные научные исследования в современном мире // Журнал - Переяслав-Хмельницький, 2018. - Вып. 5(37), ч. 1 – 170 С., с.87-90.

NGUYEN ANH TUAN, PhD (Engineering),
Faculty of Mining, Hanoi University of Mining and Geology,
Vietnam

DETERMINING FOR AN OUTPUT CAPACITY OF DIMENSION STONE EXPLOITATION FROM THE COMPUTER SIMULATIONS TO GENERATE THE FRACTURE NETWORK IN 3D

Abstract: In dimension stone quarry exploitations such as the marble quarry, a literature review of the existing numerical modelling techniques has been carried out. According to Distinct Element Method (DEM), discontinuities have been treated as boundary conditions between blocks and, consequently, an accurate knowledge of joint distribution and orientation was required. The result of analyzing data and simulating in the fracture rock environment, which is applied to a mining condition of the dimensional stone quarries. The research we introduce in the output capacity of the dimension stone quarry from the computer simulations to generate the fracture network in 3D with an aim of evaluating the size of the blocks. The results of numerical models have been used to optimize some of the technical parameters for dimensional stone extraction and ensuring stable bench in the mining operation.

Keywords: Discontinuities, Modelling, DEM, Dimension stone quarry.

References

Heliot, D., 1988. Generating a blocky rock mass. *International Journal of Rock Mechanics and Mining Sciences & Geomechanics Abstracts*, 25(3), pp.127–138.

Hoek, E. & Bray, W., 2004. *Rock Slope Engineering civil and mining* 4th ed. C. D. Wyllie & C. W. Mah, eds., London and New York.

Laego-École des Mines de Nancy-INERIS, 2008. *RESOBLOK, Manuel d'utilisation V5.03*,

Merrien-Soukatchoff, V., Korini, T. & Thoraval, A., 2012. Use of an Integrated Discrete Fracture Network Code for Stochastic Stability Analyses of Fractured Rock Masses. *Rock Mechanics and Rock Engineering*, 45(2), pp.159–181.

Nguyen, A.T. et al., 2016. Grouping discontinuities in representative sets: influence on the stability analysis of slope cuts. *Bulletin of Engineering Geology and the Environment*, 75(4), pp.1429–1444.

Nguyen, A.T., Merrien-Soukatchoff, V. & Vinches, M., 2014. Grouping discontinuities of fractured rock mass into main sets :

consequences on the stability analysis of open pit benches. In D. 2014, ed. *DFNE 2014*. Vancouver, Canada, pp. 1–8.

Nguyen, T.A., 2016. Stability conditions of jointed rock slope with contact dynamics method. , 56, pp.11–19.

Nguyen Anh Tuan, Pham Van Viet, Tran Dinh Bao (2011), “Optimization of some technical parameters for mining dimensional stone by wire saw machine”. *The 22nd National Conference on Mining Science and Technique*, Pages 171-280.

Nguyen Anh Tuan, Pham Van Viet, Le Van Quyen (2016), “Modelling of the rock mass and discontinuity structure aided design and planning methodology for marable Thung Khuoc quarries, Vietnam”. *Advances in Mining and Tunneling (ICAMT 2016)*, pages 66-74.

Priest, S., 1993. *Discontinuity analysis for rock engineering*, Chapman & Hall.

Rockscience Inc, 2003. DIPS.

Thoraval, A., 2005. Aide au dimensionnement de l’exploitation de marbre en carrieres southerraines par modelisation numerique. In Institut National de l’Environnement Industriel et des Risques (INERIS), ed. *Séminaire de restitution et de valorisation des travaux INERIS -réseau des LPC*. Paris, France, pp. 159–168.

Verdel, T., 1999. *Le logiciel STAF*, Nancy, France.

Warburton, P.M., 1981. Vector stability analysis of an arbitrary polyhedral rock block with any number of free faces. *International Journal of Rock Mechanics and Mining Sciences and Geomechanics Abstracts*, 18(5), pp.415–427.

Exploratory report of Thung Khuoc quarry in Quy Hop Town, Thung Nang Commune, Quy Hop District, Nghe An Province, 2012.

Thoraval. "Analysis of the fracturation from the underground quarries of Levigliani, Lasa, and Dionyssomarble", *Brite/Euram Project BE-5005*, INERIS report 21036/RN02, 2005.

T.Korini. «RESOBLOK», INERIS and Ecole des Mine de Nancy, 2008.

UDC 622

A.A. ADAMCHUK, Master of Mining, Senior Research Engineer, National Technical University, “Dnipro University of Technology”, Ukraine

O.O. SHUSTOV, PhD (Engineering), Associate Professor, National “Dnipro University of Technology”, Ukraine

O.P. HLADUN, Business Planning and Economics Specialist, Lead Engineer, National Technical University Dnipro Polytechnic, Ukraine

SYSTEMATIZATION OF CAREER VEHICLES AND JUSTIFICATION OF THEIR EFFECTIVE APPLICATIONS IN THE CONDITIONS OF FINALIZING STEEP DEPOSITS

Quarry transport is one of the surface mining processes, which is characterized by a significant volume of freight traffic with periodic movement of transport communications at relatively small transport distances with significant inclination angles of roads. The main types of quarry transport are automobile, conveyor, rail, skip and combined.

When steep deposits are developed the number of mining operations decrease intensively, working area becomes smaller, the number of rock ledges in mining process increases, opening and finalizing of the deep part of a deposit becomes more complicated. In this regard, when the deep quarries are developed rock mass is transported using combined transport schemes with automatic dump trucks at the deep quarry horizons [1]. Nowadays, the most popular schemes of combine transport at the deep iron ore quarries of Ukraine are automobile-conveyor, automobile-rail and rail-conveyor.

The main parameters of quarry automatic dump trucks are load capacity, engine power, body capacity, formula of the wheel and minimal turning radius (8.7 – 20 m), length, width and speed of movement. They are applied in conditions of intensive movement of cavities and very fast bedding of mining operations at the different productivity of quarries, from several hundred thousand to 70 – 100 million tons of rock annually and rock mass transportation distance up to 4 km (in some cases 6 – 7 km) and also during construction of quarries.

Main parameters of rail transport are engine power, dump car load capacity, and dump car capacity, total weight of locomotive and dump cars, formula of the wheel, minimal turning radius, moving speed, railway width, guide slope and coefficient of packaging. For the development of transport communications in railway transport, a large length of the work front on the ledges (over 300-400 m), curves of a large radius (more than 120-150 m), small ascents and slopes of roads (25-40 ‰ and in special cases up to 50- 60 ‰). Therefore, in deep quarries, railway transport is used mainly in the upper and middle zones above 150-180 m, and only with powerful traction means and sufficient plowing sides of the career to a depth of 250-300 m.

Railway is the cheapest transport among all types of quarrying. Analysis of statistical data showed that the cost of 1 ton - kilometer of rock mass transportation by rail in iron ore quarries of Ukraine makes about 9 US cents [2].

Conveyor transport is characterized by the continuity and rhythmical movement of cargos, the possibility to increase the productivity of extraction and loading equipment (up to 20-25 thousand m³ / h or more), simplifying the overall labor organization and reducing the labor intensity of operations [3]. Its specific parameters are: belt width, distance between rollers, drive power, speed of the belt, drive drum diameter, throughput, lifting height, stack incline angle.

The most common means of conveyor transport in open development of iron ore deposits of Ukraine are conveyor inclined complexes with an angle of 14-18°, located in the underground gallery (PivdGOK, InGOK). Less common is a steep conveyor (37-45°), which is installed on a non-working side of the quarry (Muruntau Quarry). In conditions of Ukrainian iron ore quarries, the use of steep conveyors on the South and Yerstivskyy GOKs is planned for the near future.

Skip transport is characterized by the following parameters: load capacity, speed of skip movement, slope angle, coefficient of container, capacity of installation, lifting height. The principle of operation of the skip quarry lifts is the displacement of the rock mass by means of cable traction in self-unloading trolleys along the rail track, laid in a steep trench or on the pillars erected on the quarry's

board. The skips for lifting the rock mass at a height of up to 500 m without prior crushing with productivity of 18 million m³ are applied [4]. The installation capacity decreases with increasing the height of lifting rock mass with the skips.

The peculiarity of operation of the skip lifts is that during movement of the loaded skip up, the empty one, connected with it through the system of ropes and blocks, moves upward, due to what the “dead weight” value is close to zero.

Conclusions.

The compiled classification of transport vehicles allows to conclude, that in conditions of iron ore quarries of Ukraine with production capacity of 10-30 million tons of ore per a year above 180-200 m it is expedient to use rail transport.

When deeper area is reached, this transport should be used in combination with automobile transport until reaching a depth of 200-300 m, depending on the deposit bedding conditions.

It is necessary to build reloading point on a depth of 250 – 300 m for automobile-conveyor transport, which will be moved each 40-90 m.

Railway cycles at the same time should be eliminated starting from the lower and to the upper horizons in order to make it possible to operate the rail transport on upper horizons and not to make the quarry boards wider, but to increase their slope angles.

References

1. Drizhenko A.Yu. Vidkryti hirnychi roboty, Dnipro: NHU, 2014, 590p.
2. Babets, Ye.K., Melnykova I.Ie., Hrebeniuk, S.Ia., Lobov, S.P. Doslidzhennia tekhniko-ekonomichnykh pokaznykiv hirnychovydobuvnykh pidpriemstv Ukrainy ta efektyvnosti yikh roboty v umovakh zminnoi koniunktury svitovoho rynku zaliznoi rudy : monohrafiia. Kryvyi Rih: Vyd. R.A. Kozlov, 2015, 391p.
3. Korolenko M.K., Peregudov V.V., Fedin K.A., Romanenko A.V. Protasov V.P. Sovershenstvovanie transportnykh skhem vydachi rudy dlya uslovij OAO «YUzhnyj GOK», Krivoj Rog: Dionis, 2012, 344p.
4. Shyrin L.N., Pryhunov O.S., Denyshchenko O.V. Transportni kompleksy karieriv: navch. posib, Dnipro: NHU, 2015, 242p.

W. KOZIOŁ, Prof. DSc. PhD. Eng., Full Professor,
I. BAIC, DSc. PhD. Eng., Associate Prof., Branch Director,
Institute of Mechanised Construction and Rock Mining – Branch in
Katowice, Poland

EXTRACTION OF ROCK RAW MATERIALS IN POLAND

Rock raw minerals, also called non-metallic or building raw minerals, include a vast and diversified group of rocks, covering all solid minerals except for energy, metallic and chemical raw minerals. The group includes both very hard and hard minerals (including block minerals), crumbly minerals (sands, gravels) and argillaceous minerals (clays, etc.). Genetic and petrographic classification of rock minerals distinguishes about 50 lithological variants including various rocks of magma, sedimentary, metamorphic and hydrothermal origins. It is obvious that such a vast assortment of rocks has to be diversified in terms of structure, mineral and chemical composition, physical and mechanical properties, workability, application, etc. The basic common feature of those minerals is that they are located at small depths (in the subsurface layer) and they are commonly extracted in the way of opencast mining (underground mining methods are hardly ever applied). For the reasons of practicability very often a simplified division of mineral materials is applied, which consists of the six following main groups of minerals [2]:

- broken and block stones including rocks extracted for the production of crushed road and construction aggregates as well as block stone, dolomite, refractory quartzites, magnesites;

- natural sands and gravels;

- carbonate and sulphate raw materials (cement-lime minerals, natural gypsum, chalk, anhydrite);

- argillaceous minerals (ceramic and refractory clays, loams, kaolin, etc.);

- industrial sands (glass and molding sands, sands for cellular concrete and sand-lime bricks) and backfilling sands;

- other sands extracted in small quantities (amber, banded quartz, phyllite, quartz and , mica shales, etc.).

Rock raw minerals play the key role in the construction industry, and they are also base materials for many other branches of economy. In 2017 extraction increased to about 320 million Mg. In consequence, in the period of almost 30 years the share of rock raw mineral extraction in the total extraction of solid minerals in Poland increased from about 36.8% to 66.9%. The most significant among the raw minerals are natural aggregates, which make up for 80% of extraction and more than 55% total extraction of solid minerals.

The year 2003 and the following years after Polish accession to the EU proved to be years of economic boom, which resulted in the increased demand for construction materials, mainly aggregates. In the record-breaking year 2011 the extraction of aggregated (333 million Mg) increased by 350% as compared to the extraction in 2002. In the years 1992 - 2017 characteristic fluctuations (developmental cycles) are observed in the changes in the extraction and production of natural aggregates in Poland, featuring several years of growth (7 - 9 years) followed by a 3-year decrease in the extraction [2,3].

Lately, in the years 2012-2014 we experienced decrease in the extraction by 37%, from 333 to 211 million Mg, and after 2014 the extraction increased to 256 million Mg, that is by 21% in 2017.

Assuming similar development of extraction to that of the previous cycle, it may be assumed that this period should end around 2020-2021, which is the end of co-financing of investments by the EU within current budget tranche.

Afterwards, the demand for aggregates is most likely to decrease.

Almost 100% of the sector of natural aggregates in Poland is private.

Both Polish capital, including numerous employee and family companies, and foreign capital representing renowned global construction companies are engaged in the extraction and production of aggregates.

The sector constantly undergoes ownership, organizational and production changes. After 2000 many new small mining facilities emerged.

References

1. Bilans zasobów kopalni i wód podziemnych w Polsce z lat 2007-2017, Państwowy Instytut Geologiczny - PIB, Warszawa 2008-2018,
2. Kozioł W., Baic I. Rock mining in Poland – current status and conditions for development. Inżynieria Mineralna – Journal of the Polish Mineral Engineering Society 2(42)/2018 pp. 65-72,
3. Kozioł W., Baic I., Stankiewicz J., Wydobywanie i produkcja drobnych frakcji kruszyw naturalnych oraz technologie ich zastosowania IMBiGS Warszawa - Katowice, 2018 pp. 212

UDC 622.236-047.44:622.232.72

O.O. VUSYK, graduate student,
A.M. PYZHUK, PhD, Assoc. Prof.
Kryvyi Rih National University, Ukraine

STUDY OF TECHNOLOGY TO MINING SURFACE THE ROCK MASSIF OF MINING COMBINES

The relevance of the presented work consists in solving a research task, namely, research and improvement of the technology of surface mining of the rock massif using the mining combine harvesters. To do this, take into account the data of the analyzed experience, scientific papers and design materials of the work of mining combines in domestic and foreign pits.

A deep analysis of the conditions and factors contributing to the effective open-pits development of iron ore deposits is made and forms the following conclusion that Krivbass's iron ore mines require a switch to a non-blasting technology for preparing the rock mass in excavation and loading operations. The non-blasting technology of surface mining of the rock massif makes it possible to achieve economic, energy-saving, technological and environmental effects, in contrast to the preparation of rocks by a mass explosion in excavation loading operations.

As a result of the study of the non-blasting development of the rock massif, an improved technological scheme was proposed for conducting surface mining of the rock massif by open-pit mining combine harvesters, thanks to which the mining combines can be effectively integrated into the existing technology of open-pits iron

ore deposits. To do this, all possible options for technological schemes of conducting surface mining of rocks by mining combines are considered for maximum reliability of the final results of the study.

When comparing the technological solutions to the problem of introducing half-rocky rocks and rocky rocks development, it was found that the use of Wirtgen surface miners, which have proven themselves in the field of open-pit mining, is advisable.

Non-blasting is technology of surface mining by mining combines requires the establishment of the relationship between the technological parameters of mining combines and the parameters of the elements of the system of development of mineral deposits in existing pits.

It would be economically feasible to determine the effectiveness of surface mining of the rock massif by mountain harvesters; it will take their weighted average performance per 1 hour for the accuracy of calculations. Considering the fact that it is significantly lower than the calculated and also average values achieved during the operation of surface miners, but under the same conditions of their use. It is clear that the latter is due to one before the lack of sufficient experience of their use in domestic mining enterprises. Depending on the number of mining harvesters in the work park, the pit's productivity is ensured with their well-coordinated and smooth operation.

Regarding the technical and economic comparison of the effectiveness of rock softening by surface mining by mining combines and drilling and blasting, it is necessary to take into account the rationality of using technological schemes for the operation of mining equipment.

Under the conditions of the open-pits, three variants of technological schemes for mining rocks are considered, compared with others, they are distinguished by the best technical and economic indicators and the rationality of using mining equipment.

The first version of the softening of the rock massif is carried out when performing drilling and blasting operations, followed by loading rocks into the vehicle.

In the second variant, the rock mass is softened by surface mining when using mining combines instead of drilling and blasting.

The third option is characterized by the use of surface mining of the rock massif, extraction and loading of rocks by a mining combine in a vehicle and the use of other auxiliary equipment to ensure the smooth operation of the mining combine.

Comparing the above options based on the results of various research works, it can be concluded that the use of the technology of surface mining of the rock massif by surface miners increases the profitability of rocks mining by $2 \div 3.5$ times compared with the technology of drilling and blasting operations. Moreover, increasing the efficiency of the development of rocks depends on the thickness of the layer of milling rock massif and strength of rocks.

So, as a more effective technology for the preparation of half-rocky rocks and rocky rocks, the excavation should include surface mining of the rock massif by mining combines compared to the preparation of rocks by a mass explosion. So, as surface mining allows you to effectively switch to non-blasting technology of open-pit development.

UDC 622.352

S.V. KALCHUK, PhD (Engineering), Associate Professor,
Zhytomyr State Technological University, Ukraine

S.O. ZHUKOV, Sc.D, Professor, Kryvyi Rih National University

FEATURES OF THE NON-EXPLOSIVE EXTRACTION OF A DIMENSION STONE DURING OPENCAST MINING

In dimension stone extraction technology the basic criteria of the process efficiency is its productive capacity and survival capacity of the extracted blocks. In some scientists' investigations [1,2] splitting is viewed exclusively as the task of critical stress calculation at which the splitting occurs. Here the borehole model containing holes is considered and to the walls of which splitting force is applied to. Further, the tension intensity between adjacent blast-holes is calculated. The splitting criterion is the stress field between the boreholes, the minimum value of which should be equal to the ultimate solid's tensile strength.

With the increase of the distance between the boreholes' walls the stress decrease after the quadratic law of the function $f(x)=k/x^2$. Thus, to provide enough of splinting stress in the middle of the distance boreholes it is necessary to make considerable stresses on the boreholes' walls to outperform the resisting power limits. It leads to the considerable stress elevation and to the radical fractures formation in all directions from the borehole. Besides, the model of elastic solid under the internal pressure is valid only till the tension joints appear resulting in the integrity violation of the environment. The further disruption occurs along the crack that initially appeared with the gradual radial cracks destruction process development. The radial cracks direction differs from the direction of the splitting plane. In this matter new borehole splitting approaches and models involvement is required. Making borehole stress field calculations from the walls of which radial cracks start is a very complicated task. The solution to this issue is to estimate the possibility of crack formation not just by the stress but, mainly by the stress intensity coefficient and definition of common splitting stages.

Drilling of the borehole line alongside the necessary break line full or 90% of the blocks' height is the initial splitting operation by means of non-blasting method. Herewith, the boreholes diameter varies from 36-42 mm and the borehole center distance is 200-220 mm. In first case destruction process starts in the very stone in tension ring deformation from the borehole center distance where radical cracks appear developing equally in all directions. Discoveries of the cracks increase at the labradorite quarries showed that the initial crack develop in all directions to the certain length.

The crack, direction of which is different to that of the splitting, gradually stops. All direction radical cracks, as a rule, they spread all over about 16-28 mm. The further crack continues increasing primary in the direction coinciding with the splitting plane. Before now the splitting around the crack model was aimed at defining tension intensity coefficient for the n quantity of radical cracks solved by means of conformal presentation [3]. According to this with the increase of crack length, tension intensity coefficient does increase as well. For this model the tension intensity coefficient is defined by the boundary collocation method [4]:

On this very stage the decrease of necessary stress for destruction process is significant, because the whole efforts will be made to grow two diametrically-opposite main cracks. With the lengthening of cracks the tension intensity coefficient grows leading to the decrease of necessary splitting effort on a certain boundary. As soon as it is achieved, the final splitting occurs incrementally.

The increase of cracks number at the initial stage of their development will happen in all directions to the defined value. And the further main cracks development in the the stone direction will be caused by coincidence with the anisotropic plane (of less strength). All the cracks directions of which will differ from the initially appointed will slow down and later will completely stop. While transferring to the non-blasting methods of splitting the stone it is necessary to take into consideration the amount of destruction load because for the splitting process to start a considerably less than it was accepted before stresses are required. Besides, the maximum stresses will correspond to the initial splitting stage and according to the cracks lengthening speed it is necessary to decrease them with the aim of reducing the amount of impact on the nature. And a sudden growth of the stress concentration coefficient as soon as it reaches $2/3$ of its maximum length, it does witness a considerable decrease of the necessary splitting effort.

The increase of cracks amount at the initial stage is possible only through considerable short-term loads. The viewed models do not allow to define the definite stress value, and the splitting model estimation at the certain stages can be possible due to additional investigations of stone samples fragile splitting.

Conclusions

The defined model of the gradual stone splitting by means of radical cracks lengthening and development that is based on the stress concentration, as a criterion of cracks lengthening in the sub-dynamic range of applied loads;

At the non-blasting natural stone splitting maximum destruction stresses should correspond to the initial destruction stage, and the stress function should be destructive depending on the cracks' sizes;

The highest stress limit should correspond to the smallest stress concentration value in the crack directions different from the directional ones.

Thus, to reduce the amount of unwilling cracks formation in the stone extracting it, is possible through decreasing the level of load applied taking into consideration the main cracks length at a defined process stage.

References

1. K. Tkachuk, S. Dyniak. Blast-hole tension fields research under static-dynamic method of the block stones extraction, Herald of the National Technical University of Ukraine «Kyiv Polytechnic Institute»: Series of «Mining», pp 42-49, 24 2014
2. N.T. Bakka. Technological structures for decorative stone monoliths splitting from an array by non-explosive destructive compositions, The Journal of Zhytomyr State Technological University, Series: Engineering, pp 118–126, 1 2003
3. L. Berezhnetskiy. On the propagation of cracks emerging on the contour curved hole in the plate, Physicochemical Mechanics of Materials, pp 21-31, 1 1966
4. J.C. Newman. An improved method of collocation for the stress analysis of cracked plate with various shaped boundaries, NASA Technical report: TN D-6376, pp 1-45, 1971.

UDC 622.235

A. A. FROLOV, Doctor of Technical Sciences, Professor,
T. V. KOSENKO, Senior Lecturer,
N. I. ZHUKOVA, Candidate of Technical Sciences, Senior Lecturer
National Technical University of Ukraine
"Igor Sikorsky Kyiv Polytechnic Institute", Ukraine

BASES OF DESTRUCTION OF ROCKS IN NATURAL CONDITIONS OF RESERVATION

The study of destruction of rocks in natural conditions of occurrence is a difficult scientific task, since it is impossible to reproduce such a process objectively. Therefore, in order to solve this problem indirect methods are usually used.

Classical theories of strength are based on the fact that the body begins to destroy at the moment when the effort acting on it reaches a critical value exceeding the tensile strength (compression, tension or shear). Such method technique is sufficient for many technical problems solution. However, it is unacceptable for other tasks

because the moment of discontinuity starting cannot be defined by magnitude of acting stress. Notably, that comparison of long-term strength and residual deformation specifications leads to establishing a close relation between them.

Many scientists investigated the temporal dependence of strength theoretically. Particularly, some scientists did this on the basis of diffusion processes. From this point of view, the mechanism for the development of residual deformations is associated with the movement of so-called “vacancies”, and the process of destruction with the drain of these vacancies into the existing cavities. As a result, they grow, which leads to a discontinuity. Crack growth is also treated as a result of dislocation movement.

In its pure form, functions describing the dependence of the creep rate and durability on the applied stress exist for metals and homogeneous solid formations. As a rule, such a connection is not observed for rocks, but its existence is confirmed by direct observations.

However, the process of irreversible change in the shape of bodies that are complex in structure is connected with an internal disruption of continuity. The macroscopic development of plastic deformation and stress relaxation can be considered as a series of local micro-fractures. This causes a macroscopic change in the shape of a quasi-continuous body.

At the same time, the processes of continuous and non-continuous movement in bodies under certain conditions can interfere with each other. In particular, if the rate of increase of stresses in the body is greater than the rate of overstress resorption, then the gap always occurs due to inhomogeneities, although the material is fluid in its properties. Conversely, if the resorption rate of overstress is greater than the rate of their rise, then the destruction will pass through the strongest discontinuities.

Research has established that, as a result of the diffusion process, stress relaxation occurs in the grains, and stress peaks are recorded near their boundaries at concentration sites. Thus, the growth of cracks in the interlayers between the grains slows down or stops, which makes the destruction difficult and then plastic deformation occurs. Both processes usually occur simultaneously and the degree of spatial heterogeneity of fracture and deformation is determined by

their degree of predominance in the material. In particular, depending on the conditions of dislocation, they can contribute either to destruction or to plastic deformation.

The development of a brittle crack is possible only under the condition of obstructed plastic deformation. Its presence will reduce the stress concentration, and also exclude the possibility of the formation and development of cracks. Thus, the stresses at the places of concentration do not increase and therefore the development of plastic deformation occurs.

The effective destruction of an inhomogeneous material consists not only of the difference in the material composition of its structural elements, but also of the concentration of stresses near them.

Thus, a real inhomogeneous body can be imagined as an environment in which stress concentrators operate, and two processes compete in places of concentration - the growth of cracks under the action of stresses and the reduction of these stresses due to their relaxation as a result of the formation of irreversible deformation.

However, the effect of plasticity of rocks on its sensitivity to stress concentration presented by some scientists is controversial. It has been established that if a material is prone to significant residual deformations, then it is not sensitive to stress concentration.

In this connection, a model of a collapsing environment, which gives the development of two contradictory processes in a mountain range is proposed: the crack growth at a rate depending on a stress and the reduction and equalization of local stresses as a result of the formation of residual deformations.

In mathematical problems which have a technical direction, the microscopic properties of the environment are determined as an average value with respect to the properties of its microelements.

The proposed problem is inverse in some extent since it is necessary to consider the effect of given macroscopic material parameters on the development of cracks in inhomogeneities.

Due to the fact that this problem takes into account the relaxation properties of the material and that the destruction process is considered in time, array heterogeneity should be characterized in another way (than it is done in the statistical theory of strength).

Assume that the constant characteristics of researched material are constant, and there are external and internal boundary conditions in the body, which create local stress concentrations at many points in case when external loads to the material are evenly applied, at these points, the value of some components of the stress differ from the average.

If this state is used for making a model of material, that has undergone the deformation at a certain speed, then it can be represented as consisting of separate geometrically identical structural elements, but with different elasticity.

The process of the solution of the problem with such presentation of the material is much simplified.

UDC 622.013: 622.3

M. V. SHOLOKH, Cand. Sc. (Eng.), Associate Professor
Kryvyi Rih National University, Ukraine

**OPTIMIZATION OF CORRELATION OF LOSSES OF
BALANCE-INDUSTRIAL SUPPLIES AND OBSTRUCTION
OF CONTENT OF QUALITY INDEXES OF MINERALS IS IN
THE STREAM OF IRON-ORE MASS**

Setting of norms of balance-industrial supplies of hard minerals consists in determination of optimal correlation of losses of balance-industrial supplies and obstruction of content of quality indexes of minerals in the stream of iron-ore mass, that for the case of working contacts longitudinal characterize a parameter. On the set technology of mountain works and processing of content of quality indexes of the iron related to magnetite in the stream of iron-ore mass optimal

estimation of losses of balance-industrial supplies and obstruction of content of quality indexes of minerals in the stream of iron-ore mass, that certainly by the method of variants of working off contacts or analytical method by being of extremum of technical-economic model of prognostication of the system «a quarry is an ore mining and processing factory».

Method of variants universal, but is labour intensive and does not allow exactly to expect optimal correlation, that is why will take advantage of analytical method of optimization singing-relation of losses of balance-industrial supplies and obstruction content of quality indexes of minerals in the stream of iron-ore mass by determination of a maximum of mathematical technical-economic model of income. Will analyses influence of losses of balance-industrial supplies and obstruction of content of quality indexes of minerals in the stream of iron-ore mass on an income that gets an ore mining and processing combine because of the activity, determine as a difference of cost of concentrate and complete charges on its production. The amount of the obtained balance-industrial supplies and concentrate withdrawn from them is bound by dependence $Q_K = \mathcal{M}\gamma_K$, where γ_K is an exit of concentrate, part of units. Complete charges on the production of concentrate fold from charges on industrially-balance supplies and transporting of the obtained iron-ore mass, on the exception of content of quality indexes of the iron related to magnetite, and charges, on the booty of opening breeds. In addition, an enterprise must bring in paying for the bowels of the earth and make amends for injury to the state through industrially-balance supplies with the use of earth under a quarry (mountain taking), dumps of opening breeds, and industrial ground.

An ore-mining enterprise gets an additional income from realization of breeds of opening and milltailings of content of quality indexes of iron related to magnetite after processing. Thus possible cases: losses of balance-industrial supplies and obstructions of content of quality indexes of minerals in the stream of iron-ore mass influences on the size of additional income; losses of balance-industrial supplies and obstructions of content of quality indexes of minerals in the stream of iron-ore mass does not influence on the size of additional income.

Meet the second case more often at the robot of ore-mining enterprises that is part of the first and will consider him at development of technical-economic model of combine. The size of income that gets ore-mining enterprise depends on that, or loses industrially-balance supplies in an array or loosens and takes out in a dump. At working off the high-dipping balance-industrial supplies of deposit, bed, ore body or areas of array of hard minerals lose only loosening balance-industrial supplies. At deposits, beds, ore bodies or areas lose balance-industrial supplies both in the loosening state (contacts of hanging side of bed) and in an array (contacts of laying side). For simplification of researches we are work out models for every type of balance-industrial supplies lose that. Optimization of balance-industrial supplies of hard minerals mathematically and logically legitimate only at complete them contoured, at $B=of\ const$, and the known quantitative, quality and technological descriptions.

In careers is both connected at working off contacts losses balance-industrial supplies and obstruction to content quality indexes minerals in a stream iron-ore mass and independent from each other (flying away of pieces of iron-ore mass and breeds, cleaning out of ballast). The last are caused by technological reasons and are the proportionally liquidated balance-industrial supplies. At working off contacts determine dependence between the careening bone of losses of balance-industrial supplies and obstructive content of quality indexes of minerals of breeds the chart of working off contacts. Charts of working off working over off contacts brought to the chart longitudinal with flat hay-crops after correlation amounts of balance-industrial supplies, lose that obstructive content of quality indexes of minerals of breeds.

Thus, amount of balance-industrial supplies lose that and obstructive content of quality indexes of minerals of breeds in a career determine as.

Determine to the normative determination parameter for the case of working off the contacts of spilt and correlation of amount and volume of balance-industrial supplies, lose that and breeds of obstruction of content of quality indexes of minerals at working off contacts with different content of quality indexes of the iron related to magnetite, in balance-industrial supplies, lose that and obstruction content of quality indexes of minerals breeds in the case when ore

mining and processing a factory can do all obtained balance-industrial supplies that is got at correlation of losses of balance-industrial supplies and obstruction of content of quality indexes of minerals in the stream of iron-ore mass, corresponding normative value parameter for case acquisition contact longitudinal splits.

Calculations of normative values of parameter for the case of working off contacts longitudinal splits from simplify in comparing to the method of variants and continuous perfection of methodology of setting of norms of balance-industrial supplies of hard minerals.

Determine AV content of quality indexes of the iron related to magnetite, in balance-industrial supplies infinitely thin layer on the hay-crop of ledge at working off a contact longitudinal split with flat hay-crops.

Official and driven to technical literature methodologies of setting of norms of losses of balance-industrial supplies and obstruction of content of quality indexes of minerals do not take into account a loss, that inflicts to the national economy an enterprise from an exception from earth and use of breeds of opening and milltailings of content of quality indexes of the iron related to magnetite, that it is taken into

UDK 622.271.33

S.A. LUTSENKO, PhD (Engineering), Associate Professor

E.N. SHVETS, PhD (Engineering), Senior Lecturer

Kryvyi Rih National University, Ukraine

M.V. MARTYNIUK, PhD (Engineering), leading technical

department specialist, PJSC “Yuzhniy GOK”, Ukraine

ENHANCEMENT OF METHODS OF DETERMINING THE BOUNDARIES OF OPENCAST MINES

At present time, while developing steep iron ore deposits, the surface lineaments of most opencast mines reached their final grades. The development of mining occurs only after they get lower. In these conditions of deposits' development it is necessary to evaluate the resources of supply of raw materials for further development of mining plant.

Experience has proven that the depth and location of end boundaries of most of the major opencast mines are reevaluated and corrected multiple times during the development of mineral deposits. However, it is necessary to determine the end boundaries of opencast mines' development that ensure the effectiveness of opencast mining. This issue is particularly important while projecting new mining plant while the similar mining plants are already operating.

While determining the boundaries of opencast mines the economic stripping ratio is calculated based on the technical and economic indexes that were reached at the time of projecting and its value is constant. The analysis of mining and concentration complexes showed that their economic indexes and stripping ratios change through time.

That is why the purpose of this research is to prove that the economic stripping ratio is a variable value that changes through time and greatly influences the end depth of opencast mine development.

Based on the above statements, the condition for competitiveness of projected opencast mine can be phrased in the following way: the stripping ratio of the projected opencast mine cannot exceed the economic stripping ratio.

It is worth noting that in the regulatory documents that regulate the operation of mining plants with opencast mining method, the rated economic stripping ratio used to determine the end depth of opencast mine is assumed as a constant value.

However, this base rival plant carries on with its operation and, through time, its economic indexes will be changing, in our case – the final cost of ore. It is caused by the change of current stripping ratios upward and downward.

By the example of opencast mines, which reflect the unique features of developing steep deposits of Ukraine, the article demonstrates the influence of current stripping ratios of operating opencast mines on economic stripping ratio, which is the primary factor in determining the boundaries of opencast mining for the projected opencast mines.

The developed method of determining the boundaries of opencast mines specifies the application of economic stripping ratio as an

inconsistent value that changes through time and depends on the changes of current stripping ratios at the rival opencast mines.

Thus in order to determine the boundaries of projected opencast mine the economic stripping ratio should be determined with consideration of possible change of volumes of overburden extraction and ore extraction at base rival plants, i.e. with consideration of change of their current stripping ratios.

It was proved, that the deviation of end depth of development of conventionally projected opencast mine, determined based on the comparison of its current stripping ratios with current stripping ratios of conventional base rival opencast mines, from the end depth of development determined with economic stripping ratio may amount to 14 to 45%.

As a result, the theory in the area of determining end boundaries of opencast mines was enhanced.

The new method differs from the existing ones by the accounting of change of economic stripping ratio through time, as well as the determining of influence of technological factors of rival opencast mines on the end depth of the projected opencast mine.

UDC 622.271

Y.I. HRYHORIEV, Ph.D (Engineering), assistant

Y.M. NAVITNIY, Ph.D, assistant professor ,

S.O. FEDORENKO, Senior Lecturer of the Department

of Open Pit Mining, Kryvyi Rih National University, Ukraine

METHOD OF FORMATION OF TECHNOGENIC DEPOSITS OF BULK TYPE USING OREPASSES

The growth of the volume of material production increases the need for mineral raw materials, so volumes of mining, which promotes the search for new sources of mineral raw materials.

Modern world trends in the implementation of resource-saving technologies encourage as a source to consider waste mining and concentrating production, which occupy large areas of fertile land and worsen the environmental state.

In addition, the attraction of such waste to secondary processing is due to the complication of mining and geological conditions and the cost increase of the process of extracting mineral raw materials directly from the depths.

In most cases, the development of bulk technogenic deposits is economically feasible. This is due to lower costs for the preparation, excavation and transportation of rock mass. Also, the terms of development of technogenic deposits are much smaller than geogenic, since the period of disclosure is much shorter or completely absent.

In addition, it is necessary to develop an effective scheme for the development of technogenic deposits, based on indicators of the state of the rock massive, mining technical conditions of development, as well as the method of disclosure and formation of the working zone.

Such technology of working out of technogenic deposit was developed. Formation of technogenic deposits takes according to usual technology adopted by the company for the dumping.

The development of technogenic deposits is following the next scheme. On the board of technogenic deposits on supports constructed system of open orepass.

Pneumatic wheel loaders move on the surface of the technogenic deposit, excavate the necessary kind of raw material and deliver it to the receiving capacity of the orepass. The gravity is delivered rocks to the vibrating feeder and transmitted to the railway transport.

It was found out that the technical and economic parameters of the company influence not only the accepted complexes of mechanization, but also the ratio of the main parameters of the technogenic deposit.

Therefore, the next step of the study was to analyze the connections of the main parameters of the technogenic deposit.

In the course of the research, it was determined that the capacity of the technogenic deposit influences the specific cost of its formation and development.

Thus, with an increase of the volume of technogenic deposits, the specific costs of its development are reduced, while the specific costs for the formation of technogenic deposits are increasing.

This is due to the increase in the distance of the transport of overburden in the period of formation, which depends on the number of tiers in the technogenic deposits.

Also, the cost of working out is influenced by the distance of transportation of dry mineral raw materials on the technogenic deposit surface, as the size of the deposit increases the range of transportation of the rock mass to the orepass, accordingly, the productivity of the loader decreases.

It has been shown that the technical and economic indicators of the enterprise is influenced not only by complexes of mechanization, but also the ratio of the main parameters of the technogenic deposit.

Therefore, the next step of the research will be to analyze the interdependence of the main parameters of the technogenic deposits.

UDC 622.271.324

V.K. SLOBODYANYUK, PhD (Engineering), Associate Professor, Kryvyi Rih National University, Ukraine

S.YU. PENKAL, student, Kryvyi Rih National University, Ukraine

DESIGN OPTIMIZATION OF THE SHOVEL RELOADING POINTS FOR THE ROAD AND RAIL TRANSPORT

The department of open pit mining operations at our University is continuously being carried out the researches aimed at improving the transport system of deep iron ore open pits [1-4]. Byzov V.F., Prof. Dr.-Ing., paid much attention to the issues of road and rail transport optimization. The location of reloading points directly in the working area of open pit mines using the road and rail transport leads to the complication of transport flow chart. Because of the need to bypass the rail dead-end tracks, the truck haulage distance significantly

increases. In order to solve this problem, a collapsible overpass was developed to allow eliminating an intersection of cargo flows by road and by rail and curtailing the truck haulage distance [1].

Since the depth of the open pit grows, the rail transport loses its efficiency mainly not because of the lesser gradient (30-40‰ vs. 80‰) in comparison with the road transport, but because of the need to freeze a section of the pit wall in order to locate the reloading points for shovels. By eliminating the afore-mentioned shortcoming, it is possible to improve significantly the efficiency of road and rail haulage in the open pit mine. The article [3-4] proposes a new method of arranging and operating a reloading point for shovels.

Drawbacks of reloading points equipped with the rope shovels are that during operation of the reloading point, the trucks and dump cars intersect that leads to a decrease in the tonnage capacity of trucks, and unloading the trucks at a level higher than the shovel is located makes it impossible to combine the handling operations in time and space. This causes a decrease in the shovel performance and an increase in the distance haulage of rock mass by trucks. In order to locate the reloading point, it is necessary to deactivate a section of the pit wall that resulted in a decrease in the rock mass output. The developed technology reduces the negative impact of reloading points on the dynamics of mining operations, increases the tonnage capacity of trucks due to eliminating the additional lift of rock mass by trucks and avoiding the intersection of roads and railways (Fig.1).

The mining operations using the developed technology are made as follows. A backhoe hydraulic shovel (1) excavates a receiving trench (2). This trench (2) is conditionally divided by width into two sections: the unloading wall (3) and the loading wall (4). The receiving trench (2) is filled with rock mass on the unloading wall (3) by trucks (5). In the general case, in order to prevent from intersecting the haul roads, the receiving trench wall (2) located closer to the lower pit benches is the unloading wall (3). The receiving trench wall located closer to the higher pit benches is the loading wall (4). The rail track is located (7) along the loading wall (4) of the receiving trench (2).

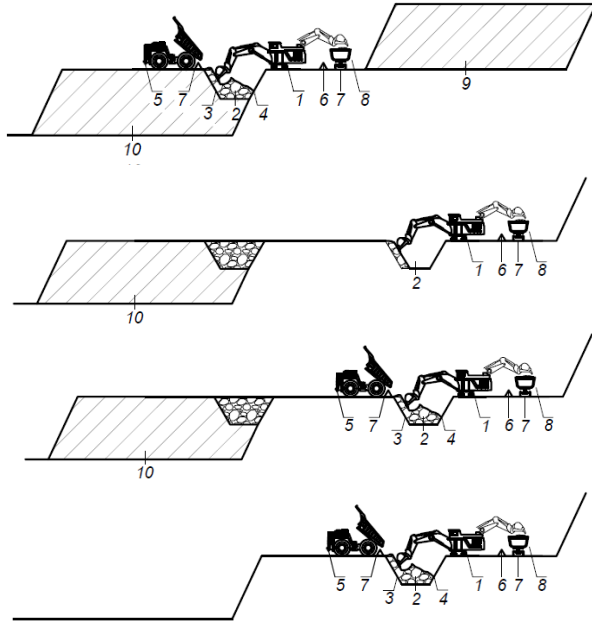

Fig. 1. Diagram of mining operations when shifting a reloading point

The rock mass from the receiving trench (2) is reloaded by a hydraulic shovel (1), located on the loading wall (4) of the receiving trench (2) onto dump cars (8) located at the level of the hydraulic shovel.

The reloading point in the given place operates until the higher benches (8) are mined out. After this, a backhoe hydraulic shovel (1) excavates a new receiving trench (2) on the extended site. After commissioning the relocated reloading point, the lower benches (9) are mined out. In order to increase the capacity of the reloading point, two or more backhoe hydraulic shovels are placed on the loading trench wall at a safe distance from each other. The use of the proposed reloading point design provides an increase in the capacity of mining equipment and reduces the negative impact of open pit transport on the dynamics of mining operations. The reloading point of the proposed design is easily relocated as the mining operations progresses and does not freeze the pit wall.

Minimum operation of the open pit transport, being the first link

of road and rail transport, will be provided if the truck haulage distance of maximum rock tonnage to the reloading point will be minimum. This imposes a number of requirements on the optimum mining technology, such as the use of more powerful shovels on the border of adjacent links of combined transport and the possibility of operating the second link of combined transport without freezing the working pit wall. The second requirement is fulfilled when using the developed design of the reloading point for shovels.

References

1. Влияние пересечений автомобильных и железнодорожных грузопотоков на работу автотранспорта карьеров / В.Ф. Бызов, Ю.Г. Вилкул, С.В. Литвинов, В.А. Завсегдашний // Разработка рудных месторождений : респ. межвед. науч.-техн. сборник / отв. ред. В. Ф. Бызов. – К., 1989. – Вып. 47. – С. 69-74.
2. Vilkul Y., Slobodyanyuk V., Maximov I. Optimization of capacity and the number of crushing and transfer stations at the deep open pits. Metallurgical and Mining Industry. 2016. No. 4. pp. 116–120.
3. Slobodyanyuk V., Turchin Yu. Rational use of hydraulic excavators in iron ore pits. JOURNAL OF MINING AND GEOLOGICAL SCIENCES. University of Mining and Geology "St. Ivan Rilski". 2017. No. 60. pp. 21–26
4. Slobodyanyuk V., Maksimov I., Slobodyanyuk R. Influence of mutual arrangement and performance of shovels on the position of an optimum point for run-of-mine stock location. JOURNAL OF MINING AND GEOLOGICAL SCIENCES; University of Mining and Geology "St. Ivan Rilski". 2018. No.61. pp. 28–32.

UDC 622.271:622.17: 625.731.4: 624.131.537

K. TOMICZEK, PhD (Engineering), Assistant Professor, Silesian University of Technology, Poland

STABILITY SIMULATIONS OF THE MULTI-LEVELER DUMPS MADE OF MINING WASTE

The analysis aimed at designing an outline of a multilevel dumping ground/embankment built of post open-cast mining waste and post-mining waste.

No information on the strength properties of the material was delivered plus the contractor did not plan to conduct laboratory tests. Properties of mining waste were unknown and data on them

unavailable. Therefore, back-analyses were conducted and the values of cohesion c and internal friction angle ϕ were determined. The summary of these researches is presented in previous paper.

The results of calculations and forecasts have been positively verified in in-situ conditions by the behavior of the already built embankment.

The opencast mine is located in the western part of the Lesser Poland Voidvodship and covers a surface area of 1.0km \times 1.3km. Mine areas cover the hills with steep slopes and of heights from +360 to +400m above sea level. The morphology of the area is modified by mining activity. Formed mining waste dumps change the natural landscape.

The exploitation of the limestone, dolomite and marl deposits is conducted on three levels: +322, +314 and +305m above sea level. In the northern part of the opencast mine, the exploitation reached the III-rd level of the floor (+305 \pm 3m), where the sump is located.

The operation is conducted in a way that makes the floor of the excavations even tidy which means that the irregularities are levelled plus slopes and sides of work are formed. Forestry-based recultivation with majority of deciduous trees is managed on an ongoing basis.

Waste material from dumping grounds is used in the process of land recultivation. The amount of the waste material is insufficient. Thus rock gravel aggregate with technical and hygienic certificate has been also used for macro-leveling.

Behavior simulations of the embankment and its stability for the case in which (Fig.) the shelves are built from +305m were conducted. The height of shelves No. 1, 2, 3, 4, 5 and 6 is equal to 8m. The height of shelf No. 7, from the level +353 \div +360 is equal to 7m. The slope angle is 45°. The width of each shelf is equal to 7m.

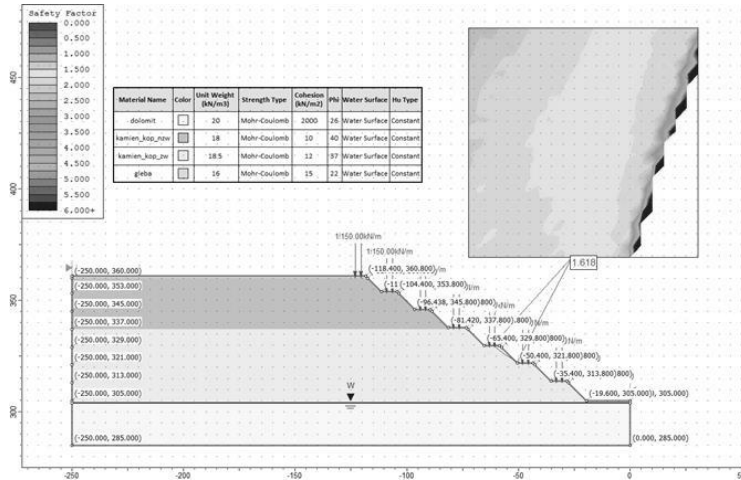

Fig. Model after building the 6th shelf (+305÷+360). Vectors of forces caused by the load of cars carrying material were applied. The horizontal surfaces of the shelves were covered with a 0.8m thick layer of soil, and the slopes - 0,3 m. The inclination angle α is 45°. The value of the stability coefficient $k(F)$ is equal to 1,62

After accomplishment of the embankment construction, the dump slopes are covered with a soil layer of about 0.3m, the shelves and the top surface with a soil layer of 0.8m. Trucks driving on shelves are to generate vertical forces of $2 \times 150 \text{ kN/m}$. The possibility of collapsing wheels of the loaded trucks into the shelves' foundations is not considered.

Summarizing, based on calculated material constants, embankment models were built. The embankments' stability was based on the calculated values of the slope safety/stability coefficient $k(F)$. The methods of Bishop, Janbu and in some cases of Fellenius were used.

The calculations were made for the assumed slope (inclination) angle α equal to 45°. The calculations were divided and taken into stages as described previously. The calculations were made for two variants differing in the level of leveling. One of the variants is described and presented on Fig. and Tab.

For both variants, values of the safety/stability coefficient $k(F)$ were always greater than 1.5. In general, for assumed values of c and constants, the embankment stability was predicted for slope angle

equal to 45°, shelves with height h equal to 8 m and width w equal to 6÷7m for the height from +305÷+360 m.

Type of material	\square kN/m ³	c kPa	\square °	Comments
Dolomite	20	2000	26	values from the lower range (e.g. Hoek, 2014)
Unweathered mine waste	18	10	40	values based on the results of back analysis, local vision, previous results of laboratory tests and literature studies altogether (among others, Baran et al., 2009, Charanpret, 2009, Koda and Przysiadka, 2007; Zapał, 2007, Sternik, 2011)
Weathered mine waste	18,5	12	36	
Limestone rubble	17	8	36	as above
Soil	16	15	22	as above; minimum values were adopted (including Śnieg et al., 2007)

In order to improve mechanical properties of the material, to reduce fraying, rutting, water absorbability and capillary action, as well as to increase wheel load capacity, at any stage of the embankment building density compaction should be carried out. It should be taken into action with usage of kneading machines, e.g. road rollers.

Furthermore, verbal information provided indicates that since 2014 embankments, also those for temporary dumps, have remained stable and have not slipped.

Keywords: open pit mine, stability of embankment, slope, post-mining waste, revitalization, land reclamation, land recultivation, cohesion, angle of internal friction

References (selected):

1. Cała M. *Mechanika Gruntów. Soil Mechanics. Cykl wykładów*, AGH, Kraków 2016 (home.agh.edu.pl/cała/prezentacje/, dostęp 12.06.2018r.)
2. Hoek E. *Fundamentals of slope design. Keynote address at Slope Stability 2009. 9-11 November, Chile Santiago 2009* (<https://www.rocscience.com/>, available 9.11.2018)
3. Tomiczek K. (author of the Xth chapter of the project, head of the project: J. Konior, unpublished) *Opracowanie projektu rekultywacji i zagospodarowania terenu zakładu górniczego [...] wraz z operatami wodno-prawnymi. A project for land reclamation and development of the [...] pit mine with water and legal operators. NB-114/RG-4/2014, Politechnika Śląska, Wydział Górnictwa i Geologii, KGBPiZOP, Gliwice 2014*
4. Tsyтовich N. *Soil Mechanics*. Mir Publishers, Moscow 1981
5. Verruijt A. and van Baars S. *Soil Mechanics*. Published by VSSD, Netherlands 2017
6. Wiłun Z. *Zarys Geotechniki. An Outline of Geotechnics*. WKŁ, Warszawa 1987

UDC 622.02.68: 68.502.31

O.A. BUBNOVA, PhD (Technical), Senior Researcher,
M.S. Polyakov Institute of Geotechnical Mechanics under the
National Academy of Sciences of Ukraine, Dnipro, Ukraine

GEOMECHANICAL PROCESSES IN DISTURBED AND TECHNOGENIC ENVIRONMENTS AND THEIR EFFECTS ON THE ENVIRONMENT IN THE MINING REGIONS

Nature management issues repeatedly raises by scientists of different disciplines, international and national programs are devising, but their practical result is extremely small since as a rule all developments are aimed at solving specific problems in certain enterprises. Therefore, this problem remains acute, and its solution is relevant.

Precious resource of our country is fertile land, much of which is withdrawn from the crop rotation for objects of the mining industry. Used technologies of mining and mineral processing are aimed at a more complete extraction of the useful component with the lowest material cost and the preservation of natural resources such as land and water, is taken into account the last thing (last of all).

Consequently to open-pit mining an open excavation with large area and depth formed, the fertile layer is removed and stored for decades what reduces its value. In addition, as a result of dehydration of the massif is a violation of the geological strata, including land resources and surface subsidense [1]. Such violations are not taken into account until now. Along with direct violation of the earths surface land withdrawal for location of anthropogenic objects (waste rock dumps, tailing and slime storages, gathering ponds, clamps with fertile layer) takes place.

The influence of anthropogenic environment on soil conditions by the following:

- exclusion from economic turnover of large areas of land under waste products;

- destruction or degradation of land through drifts of dust from the dumps and tailings surfaces;

- environmental pollution (soil, surface and ground water, air) by the heavy metals and salts in concentrations often exceed the permissible limits.

The issue of reducing the impact of mining on land cover can be divided into two areas: the exclusion of further exposure of the operations and the issue of already disturbed land.

As an effective solution to further exclude of the impact of mining on land resources is the following: a) storage of tailings and overburden in the area of coffins, and b) the development of waste dumps and tailings with the extraction of useful components, which will provide further capacity for waste disposal without additional set-aside and increase resource intensiveness by involving to the development of waste, and c) the transition to open-underground mining with laying of underground worked out area by overburden.

Problem solving of the existing disturbed land can be divided into the following options:

- use of disturbed lands for commercial purposes without land reclamation (waste storage, making of enterprises or recreation ares);

- conducting land reclamation in areas (biological, forestry, etc.)

- restoration of the broken massif properties and soil fertility to a natural state [2-3].

No less important resource, either directly or indirectly affected by mining is surface and groundwater.

The presence within the natural environment disordered and anthropogenic environment has a negative impact on the natural hydrological conditions, which is manifested in the change of recharge area, movement and discharge of groundwater, formation and deformation of sufficiently large cone of influence. Violation of hydrological regime of territories, as opposed to violations of the rock mass massif and the land cover is a more dynamic factor that can dramatically increase the effects of other environmental factors [1]. As a result, disturbed land are generated implicitly (impounded, waterlogged, additional subsidense, change the properties of fertile rocks).

Internal slag-heaps on existing technology forming have no hydraulic connection with the natural environment, and stacked rocks are detected. Thus, such a man-made environment, lying surrounded by natural geological environment is a barrier that prevents the movement of groundwater and surface water, which can lead to landslides and raise the water table.

External slag-heaps affect the movement of surface water and groundwater, as often have in the gullies or ravines, ie in places

where the discharge is usually ground and surface water, leading to flooding and landslides.

Therefore, it is proposed the concept of recovery of the hydrodynamic regime of underground waters in the mining pit areas, which is based on the following.

In the open cast method of mining is recommended as the main technical solutions for the conservation properties of the rocks in the environment adjacent to the breach, and to maintain the water balance of the territory to intercept groundwater flow before they reach the borders of the career and devote their corresponding aquifers outside of the career contour. The parameters of this technology depend on the career depth, quantity, capacity, and depth of the tapping of underground reservoir, the location of open-pit field relative to the direction of groundwater artery.

To preserve hydrologic regime in a man-made geological environment is proposed to intercept surface runoff drainage system with a branch in its natural place of discharge, which will not only preserve the water balance of the territory, but also will ensure safe use of man-made object.

During reclamation of man-made geological environment is proposed to restore the upper aquifers [2-3].

Future research should be directed to the study of natural geological environment disturbances and man-made features of the formation, the laws of the formation of their new properties, as well as the scientific rationale and development of technical solutions that focused on the restoration of man-made and broken geological environment properties that correspond to the natural.

Referenses

1. Chetverik M.S. and Bubnova Ye.A. Osedanie zemnoy poverkhnosti pri vodoponizhenii i potopenii teritoriy gornodobyvayushchikh regionov. *Naukovo-technichniy zbirnyk KTU, Kryvyi Rih*, 2004, vol. 86, pp. 31-36.

2. Bubnova Ye.A. Sokhranenie vodnogo balansa na narushennykh otkrytyimi gornymi robotami territoriyakh. *Geo-Technical Mechanics*, 2012, vol. 103, pp. 45-54.

3. Bubnova O.A. Vidnovlennya vlastyvostry porushenykh girnychymy robotami zemel, *Geo-Technical Mechanics*, 2011, vol. 94, pp. 17-23.

O.O. VUSYK, graduate student,
A.M. PYZHYYK, PhD, Assoc. Prof.,
Kryvyi Rih National University, Ukraine

CONDUCTING OPEN DEVELOPMENT OF SURFACE MINING ROCKS USE OF MINING COMBINES

The practice of mining enterprises shows the tendency of widespread use of non-blasting development of rocks. In which the surface mining of the rock massif is performed by surface miners to soften the rocks without conducting a mass explosion.

In the works devoted to the study of this issue, the presented results testify to the relevance of using the technology of surface mining of the rock massif by surface miners, as one of the effective technologies for preparing rocks for excavation and demonstrates its prospects. Depending on the principle of operation of surface mining machines and the physic-mechanical properties of rocks, one can determine the efficiency of surface mining. Therefore, the priority direction of research on the non-blasting technology of the development of mineral deposits is the improvement and production of it in the working conditions of existing pits. As a result of analyzing the research of this issue, a new research direction for the transition of iron ore pits to a non-blasting developed rock massif, which is represented by rocks of considerable strength, is proposed.

The purpose of the work is to substantiate the effectiveness of the use of the non-blasting development of iron ore deposits in case of surface mining of the rock massif by surface miners and its parameters of the elements of the development system. Industrial tests and applications of surface mining by open-pit miners of the rock massif in domestic and foreign mines, suggests that in conditions of open-pit development of iron ore deposits, surface mining can be successfully and effectively used for the development of iron ore cages of interiors. Industrial tests and applications stratified mining of open pit surface miners in domestic and foreign pits ah mining enterprises, suggests the possibility that in the conditions of open-pit development of iron ore deposits it is possible

to apply surface mining quite successfully and effectively for the development of iron ore open-pit mines.

The implementation of the integration of surface mining technology into the existing technology of open mining of mineral deposits, as a whole, is possible when solving such important tasks as:

perform in-depth analysis of modern high-performance excavation-loading equipment, which does not require a complex of drilling and blasting operations;

to establish the most optimal technological parameters of the excavation-loading equipment and the parameters of the elements of the system for the development of mineral deposits, as well as the rationality of the field of application of open pit mines.

After completing the research on the above directions and obtaining results, a real operating without explosive technology of mining the rock massif in the conditions of developing iron ore open-pits will be created.

Using the technology of surface mining of the rock massif in iron ore pits for the preliminary softening of half-rocky rocks and rocky rocks requires the study of all aspects of the technology of open-pit mining that lacks brown-blasting.

Surface mining with mining combines with sufficient efficiency and economic feasibility can be used in the development of half-rocky rocks and rocky rocks with a strength factor of $f=12-14$ with the presence of various inclusions in them with a significant strength factor $f>20$ on the Prof. M.M. Protodyakonova.

Thus, the use of surface mining by mining miners makes the technology of open mining economic and environmental.

When drilling and blasting is intrinsically labor intensive and difficult to implement, if you replace them with surface mining with mining miners, then the technology of open-pit mining of mineral deposits is significantly simplified.

Section “Shaft Sinking and Drifting”

UDC 622.023

O. KHALYMENDYK, PhD (Engineering), Associate Professor,
G. STORCHAK, PhD (Engineering), Associate Professor,
V. SHAPOVAL, DSc. (Engineering), Prof., Department of Construction,
Geotechnics and Geomechanics, National Technical University «Dnipro
Polytechnic», Dnipro, Ukraine

THE FAILURE CRITERIA FOR SATURATED ROCKS WITH EXCESSIVE PORED FLUID/GAS PRESSURES

At present, there are many various failure criteria used in rock and soil mechanics among which the Mohr-Coulomb criterion, the Bieniawski criterion, the Hoek-Brown criterion and the Shashenko criterion are the most widespread. There are also combined criteria considering several mechanisms of destruction like strains and shears.

Each of them is aimed at describing unsaturated materials except for the Mohr-Coulomb failure criterion which uses the internal friction angle φ and specific cohesion c as failure characteristics. It is not clear how one should calculate strength and stability of saturated rocks using conventional strength characteristics R_c and R_p which are uniaxial compressive and tensile strengths correspondingly. This research deals with this issue.

It should be noted that the authors do not make a distinction between ‘soils’ and ‘rocks’ as “in terms of construction, a soil is any rock used in construction as a foundation, the environment in which a building is built and a material for constructing”.

The research aims to determine the way the failure criteria (the Mohr-Coulomb criterion, the Bieniawski criterion, the Hoek-Brown criterion and the Shashenko criterion) are modified in presence of excessive pore fluid pressure to evaluate the impact of pore pressure on the critical height of the vertical slope and that of the active and passive stress on protecting structures by analyzing solutions of

classical problems in soil mechanics. The task has been set to obtain modifications of failure criteria enabling the authors to consider impacts of excessive pore fluid pressure on rock failure and stability.

The research methods include theoretical studies of geomechanical processes by means of analytical mathematical methods.

The research task is formulated in the following way:

1. There are known strength characteristics of a soil or rock (the specific cohesion c and the internal friction angle φ) or the uniaxial compressive R_c and tensile R_p strengths.

2. The specific weight of a soil (rock) γ is known.

3. The pore fluid pressure P is known.

4. The failure criterion of unsaturated rocks is known.

5. The known failure criterion is to be modified for saturated rocks.

Conclusions.

1. The Mohr-Coulomb, Bieniawski, Hoek-Brown and Shashenko failure criteria resulted in new failure criteria for saturated rocks with excessive pore fluid pressure.

2. The results allow of natural generalization for rocks under stress in the pore gas and water-gas mixture.

3. It is indicated that the obtained failure criteria have some physical sense in a limited range of pored fluid/gas pressures and a limited range of combinations of the normal principal stresses.

4. The numerical experiment establishes that excessive pore fluid/gas pressure results in reduction of rock strength:

- according to modification of the Mohr-Coulomb three-dimensional failure criterion – by 0-100%;

- according to modification of the Bieniawski three-dimensional failure criterion – by 0-90%;

- according to modification of the Hoek-Brown three-dimensional failure criterion – by 0-70%;

- according to modification of the Shashenko three-dimensional failure criterion – by 0-60%;

5. The obtained results can be applied to forecasting strength, stability and bearing capacity of saturated soils and rocks including solving such problems as stability of slopes and mine workings, definition of active stress on protecting structures.

In general, a conclusion can be drawn that all suggested criteria of rock failure have their own application range for solving the problems of strength, stability and bearing capacity of saturated soils and rocks. Meanwhile, these ranges should be defined in the course of further research and experiments.

The obtained results include modifications of the known Mohr-Coulomb, Bieniawski, Hoek-Brown and Shashenko failure criteria determining rock strength with due regard to excessive pore fluid pressure. The critical height of the vertical slope and active and passive stresses of saturated and unsaturated rocks are compared. The given results enable natural generalization for rocks in which there is some pore gas under excessive pressure.

The scientific novelty of the research includes modifications of the Mohr-Coulomb, Bieniawskii, Hoek-Brown and Shashenko failure criteria enabling consideration of impacts of excessive pore fluid pressure on rock strength and stability.

Practical significance of the research involves predicting the failure of rock in mine workings composed of water-bearing strata and support structures.

UDC 691.544

S.I. SAKHNO, PhD (Engineering), Associate Professor

L.A. YANOVA, PhD (Engineering), Associate Professor

O.V. PISCHIKOVA, PhD (Engineering), Associate Professor,
Kryvyi Rih National University, Ukraine

APPLICATION OF SINTERING DUST FOR THE INCREASE OF CEMENT DURABILITY

Annual emissions of ferriferous dust in the atmosphere of the Kryvyi Rig region are approximately 400 thousand tons. The greater amount of dust is retained in dust cleaning devices of the enterprises of mining complex. Its return in a technological process is a necessary and ineffective measure. The search of ways of her rational use continues, therefore.

The possible use of these wastes in the production of building materials have been taken into consideration. It was offered to use pulverulent ferrous wastes for the increase of activity of cements. We have carried out researches into the use of electrostatic precipitator dust of sintering production as an activator of cement hardening.

Studies have demonstrated changes in the size of dust particles and their magnetization at various stages of purification. The dust taken from the cyclone has an average particle diameter $d_{mid} = 8.55 \cdot 10^{-6}$ m, the proportion of magnetized particles in it is $n = 16.2\%$ with an average magnetic moment $I_{mid} = 0.108 \cdot 10^3$ A·m. The same dust, but taken from the 1st electrostatic precipitator has the following indicators: $d_{mid} = 6.3 \cdot 10^{-6}$ m, $n = 19.2\%$, $I_{mid} = 0.199 \cdot 10^3$ A·m, and from the 3rd electrostatic precipitator $d_{mid} = 5.39 \cdot 10^{-6}$ m, $n = 30.5\%$, $I_{mid} = 1.3 \cdot 10^3$ A·m.

Studies have revealed the possibility to use dust of sintering electrostatic precipitators as an activator of cement hardening due to the effect of chemically induced dynamic nuclear polarization (CIDNP). In the laboratory, binders consisting of a mixture of slag Portland cement and dust of electrostatic precipitators in various proportions were investigated. The amount of dust in various experiments varied from 0.1 to 5%. In the process of research, considerable attention was paid to the study of tribochemical and catalytic phenomena arising from the interaction of dust with a hardening binder.

Experiments have shown that the greatest increase in the strength of the binder, up to 80%, is observed with the introduction of dust in an amount of from 1.5 to 2%. The increase in strength largely depends on the magnetization of the particles. Dust from the third filter is able to increase the activity of the binder in ~~by~~ 1.8 times, while from the first filter no more than 20%.

Electron microscopic, X-ray diffraction and thermogravimetric studies have shown that an increase in the strength of cement stone with electrostatic dust is associated with an increase in the degree of hydration of cement and active mineral additives. Wherein, the microstructure of the cement stone is more dense and fine-grained, the degree of binding of hydrated lime by active mineral additives increases.

A mathematical model of the effect of electrostatic precipitator dust on the activity of the binder has been developed.

UDC 624.1

V.V. VAPNICHNA PhD, Associate Professor,

L. V. SHAIDETSKA PhD, Department geo-engineering National Technical University of Ukraine "Igor Sikorsky Kyiv Polytechnic Institute"

CONCEPT OF GEOMONITORING IN THE MEGAPOLIS CONDITIONS

Formulation of the problem. Constant influences of external factors and operational loads lead to the gradual demolition of structures, and with excessive loads and premature wear, irreversible deformations and destruction of structural elements. In order to control and predict the state of structural elements and structures, in order to prevent the trend of changing the geometric parameters of the structure in the direction of the development of an unfavorable situation, it is necessary to conduct periodic surveys of structures with the implementation of a complex of geodetic measurements of its geometric parameters, that is, deformation monitoring.

Analysis of recent research and publications. External factors influencing the deformation include the geodynamic effects of mining excavations, operating loads and changes in external climatic conditions such as daily changes in air temperature and solar activity (the presence of direct solar radiation on different parts of the object), rainfall (snow), seismic shocks. The main functions of the deformation monitoring system are: measurement of geometric and physical quantities, transmission, processing, accumulation and provision of information to the organization serving the construction. Deformation monitoring can be carried out periodically or continuously. Often, there is a need for both types of deformation monitoring in the process of construction of objects. One of the modern methods of deformation research is the application of an automated deformation monitoring system (ASDM). Which allows to carry out continuous measurements of deformations (landslides) of elements of the structure of an object. Satellite (GLONASS / GPS) and digital geotechnical sensors for monitoring help to detect deformation of objects beyond the regulatory range. It provides a centimeter level of accuracy in all weather and climatic conditions in

real time, using the appropriate specification and configuration of the ADSM. The principle of measurement allows you to determine the spatial position of any point of the object with the same precision and efficiency. The results of measurements of different sensors provide information on the conditions of operation of objects and their impact on the geometric stability and stability of objects. Thus, complex ASDM allows you to analyze the causes of deformation and predict the behavior of objects in general and their individual constructive elements in particular. Due to the automated system of deformation monitoring "Centaur", an automated monitoring of deformations of the structural elements of the overpass during the tunneling period of the Kurenivsko-Chervonoarmiiska metro line area in the Holiivskyi district of Kyiv was carried out.

Setting objectives. The purpose of the monitoring was to determine the deviations of the construction of the overpass bridge and the position of the beam at the pole in the plan and profile during the tunneling of the underground tunnels. Presentation of the main research material. In order to ensure the stability of the calculations and efficiency of the automated monitoring system "Centaur", the necessary number of starting points was established: on the "clover sheet" of the overpass (exit from the overpass of Akademika Zabolotny ave on Academician Glushkov ave): 4-poles polished in soil with prisms; On the pillars of the overpass with the opposite from the penetration of the panel side of the side fixed - five prisms.

To determine the rolls and draft elements of the construction of the overpass, which were observed, in certain places deformation prisms were installed: six prisms on the supports of the overpass located in the immediate proximity of the design axis of the tunnel; on the bridge of the ramp - nine prisms; On the sidewalk and road along the axis of the tunnel - sixteen points of observation.

To the approximation of the panel complex, measurements were performed to obtain zero values and determine the stability of the overpass, without additional factors affecting the foundation of the structure.

Measurements were carried out in an automatic mode by an electronic tacheometer TCRA 1201 №. 238487, manufactured by Leica Geosystems. Fluctuations in deviations can be explained by permanent and temporary loadings of the building. Prior to the

construction of the tunnel under the overpass, no significant design deviations were detected, and the results were consistent with each other. In the process of guiding the panel complex under the overpass, the following maximum deviations were recorded: $X=-11$ mm; $Y=$ mm; $Z=-9$ mm (-11 mm - Centaur). To compare the results of the study of strains in the software complex "Plaxis 3D Tunnel" a mathematical model was constructed. Engineering-geological conditions of the soil mass are composed of the following soils: the bulk soil - the capacity of 8 m, the sand - the capacity - 6 m, loam - 3 m, clay - 4 m. This tunnel passed the panel complex, the diameter of the tunnel in the light - 5,4 m, the type of fastening reinforced concrete tubes, the thickness of the tube - 0,4 m.

In the future we will follow the settling of the ground under the overpass. According to the results of the simulation, the soil subsidence is 12 mm, which corresponds to the precipitation that we received as a result of observations using the automated deformation monitoring system. In addition, we will conduct a study in which it will be known how the deformation of the earth's surface will change, depending on the change in the depth of the penetration of the transverse tunnel. Let's down this overhead tunnel at 2 m below the planned marking mark. In this case, subsidence of the earth's surface will be 4 mm, which is 3 times less than the subsidence of soil, which occurred at the actual passage of the transverse tunnel.

As a result of the combination of modern methods of engineering research, through which the data of field observations on the land surface and the mathematical modeling in the software complex "Plaxis 3D Tunnel" were obtained, we can obtain reliable results for the settlement of the soil during the construction of counterfeit workings in a megacity. This will allow more accurately and promptly take into account the specifics of a particular area and take preventive measures to preserve existing structures on the surface. Conclusions The zone of deformation of the earth's surface, which occurs during underground work, depends on the geological conditions of the forged massif and the depth of occurrence of the underground structure. The mathematical model of the deformation of the earth's surface, during underground work, created in the software complex "Plaxis 3D Tunnel" fully corresponds to the full-scale model of the deformation of the earth's surface, which was created using the automated systems of deformation monitoring "Centaur".

UDC 622.254 (477.62)

V.I. KAMENETS, PhD (Engineering), Associate Professor,
O.O. KOBYLIANSKYI, student,
M.O. FEDALCHENKO, student,
Donetsk National Technical University, Ukraine

DEVELOPMENT OF THE MINE WORKINGS CONSTRUCTION TECHNOLOGIES AT THE KRASNOARMIISK COAL INDUSTRIAL AREA MINES

The Krasnoarmiisk Geological and Industrial District is the largest and most promising supplier of energy and coke coal in Ukraine with balance reserves of billions of tons and tens of millions of tons of industrial reserves in Ukraine.

It is stretched in a northwest direction for 100 km along the stretch at a width of a strip of coal deposits of 18-20 km. It is confined to the monolithic southwest wing of the Kalmius-Toretsk Hollow. The rocks range from meridional (south) to northwest (in the center and north of the area). Fall of rocks to the east - north-east, the corners of the fall are flat - from 5 to 12-15°. It is stretched in a northwest direction for 100 km along the stretch at a width of a strip of coal deposits of 18-20 km. It is confined to the monolithic southwest wing of the Kalmius-Toretsk Hollow. The rocks range from meridional (south) to northwest (in the center and north of the area). Fall of rocks to the east - north-east, the corners of the fall are flat - from 5 to 12-15°.

Relatively calm occurrence of rocks is disturbed by tectonic ruptures of different orientation and morphology. The main disturbances in the area are thrust longitudinal sub meridional and diagonal northeast directions. The first group includes Kotlinskyi, Krasnoarmiiskyi, Mertsalovskiyi and Samarskiyi thrusts, and the second one is Selydivskiyi, Central, Dobropilskiyi, Novo-Iverskiyi. The fall of the displacers of these nests of the draft (20-40°) to the east - southeast, gradually becomes more flat with a depth of 15°. The displacement amplitudes of these disjunctures naturally decrease from 300-350 m (in the southern part of the Selydivskiyi thrust) to 15-20 m (near the northern Novo-Iverskiyi thrust) [1]. Mine and reconnaissance work in the wings of these nests revealed numerous

glacial breaks. In addition, the simultaneous conducting of works in several layers of the retinue, and weak lateral rocks also affect the state of mining. Due to the presence of large geological disturbances, a network of small tectonic disturbances and weak zones is significantly developed, which adversely affects the stability of the rocks in the course of treatment and preparatory work.

In order to assess the state of mining operations and the influence of mining and geological and technological factors on their stability, in 2013-2016 we carried out a survey of workings that are carried out and maintained at the mines of the district.

The survey covered the workings carried out by the blasting and road head tunneling technologies at depths of 600-900 m not more than five years ago. The surveyed workings were fixed: characteristic deformations of the rocks and lining, where possible, the rock contour; section size in light; displacement in the nodes of inflexibility; the size and location of cavities in a fixed space. Measurement and analysis of cavities were carried out according to the method, taking into account the experience of conducting such surveys in DonNTU, KII and DDTU (Alchevsk). The new scheme of measurements was developed. According to SNiP II-94 the permissible size of crossing of the cross section for capital workings is accepted: for breeds with strength from 30 to 60 MPa - 75 mm; for rocks with a strength of 70 to 90 MPa - 100 mm.

During the day, especially in relation to passing plants with cross-crowns, characteristic for all directions, in accordance with regulatory requirements in 2007, the age band is 200 mm, regardless of where they are located. And in the regulatory document of 2005, the allowable amount of redistribution at a cost of up to 20 MPa is 4%, at 20-100 MPa - 8% of the design area of the loop in the gateway.

The result is a proof of the presence of an interruption during the passage, which is a significant overspending, as well as during drilling, including with combine technology, up to 400-700 mm. Depending on the geological situation, in particular, for distribution, testerification, quantitative characteristics, critical deformations and changes. The margin of error of technical and economic indications of mines, stem problems during maintenance of workings.

We also have analyzed the passports of DTEK Dobropilliavugillia, “Kapitalna” coal mine and Selydivvugillia mines. Due to the low mechanization of mounting processes [2], the machine-time coefficient for road header does not exceed 0,3-0,4 during the working shift. The situation does not change for the better over a fairly long period. The experience of the leading coal mining countries of the world - the USA, Australia, Germany, Poland, the People's Republic of China - speaks of the opportunity to solve the problem of combining operations with the destruction of the face and the assembly of the mount, with the machine-time factor can be 0,8-0,9.

In Ukraine and in the CIS, new road headers are developed and serially manufactured.

One of the directions for solving the problem with combine technology is the correct choice of cutting direction of the crown for workings with a curved contour and flat projections. In the case of the presence of layers of strong rocks in the roof it is expedient even at large depths to use forms of intersection with a flat roof and reinforcement of rocks anchors.

The replenishment of stockpiles prepared for processing in the region is lagging behind due to the generally low pace of mining operations, including the outdated fleet of road headers. In recent years, in Ukraine, the levels of CPC complexes provide high speeds for conducting workings. This, in particular, has been reflected in the developed DonVUGI "Technological schemes ...", which can be applied to significantly increase the pace of mining operations and increase production.

An analysis of modern research and development in the field of conducting and maintaining workings shows that in recent years, one of the main trends in the development of tunneling equipment, both in Ukraine and abroad, has been the steady increase in the number of aggregated variants of mining machines. Thus, practically all offered tunnel combines are equipped with additional equipment - lifting racks with service areas, anchor installers, drilling machines for unloading wells etc. Thus, a modern road header of selective action should provide mechanization of fastening and the beginning of maintenance of the workings at the time of its excavation.

Section “Mine Surveying”

UDC 622.1-047.64: 622.013

M. V. SHOLOKH, Cand. Sc. (Eng.), Associate Professor
Kryvyi Rih National University, Ukraine

AN ANALYSIS OF SURVEYOR CONTROL OF LOSSES OF BALANCE-INDUSTRIAL SUPPLIES IS AT MASTERING

The considered methods of the surveyor providing of works are on determination of volumes of crop and setting of norms of quality indexes of balance industrial supplies of bowels of the earth, in that examine the losses of balance-industrial supplies and impoverishments of content of quality indexes of minerals as the determined (non-random) sizes. The conducted review of methods and technical upshots will allow to bring down losses of balance industrial supplies and impoverishments) of content of quality indexes of minerals at a booty, ware housing and necessity of variegation of content of quality indexes of minerals in the stream of iron-ore mass. It is well-proven that for the correct choice of optimal (normative) the level of losses of balance-industrial supplies and impoverishment of content of quality indexes of minerals in iron-ore mass in every concrete case of the use of criterion of estimation of economic efficiency, that full enough takes into account the difference of variants of development for operating and capital charges. The criteria of economic evaluation at setting of norms of losses of balance-industrial supplies are differential mountain rent and income that is counted on 1 τ balance supplies. Estimate rationality of process of mastering of mineral resources the indexes of plenitude of exception of them from the bowels of the earth and to the further processing.

Researchers are based on materials of work of ore mining enterprises of Krivbass that are in the central part of the Ukrainian shield that is the basic Geostructural element of south-west of the east Europe platform. The structure of Kryvyi Rih belongs to one of the most interesting geological objects of Ukrainian of shield, that

explains not only localization of bowels of the earth of unique supplies of iron-ore components but also original geological structure, history of geological development of region, that represents all basic stages of the formation. The aim of the work is the development and introduction of methodology of determination of losses of balance-industrial supplies and impoverishment of content of quality indexes of minerals taking into account the complex mastering of bowels of the earth. For the achievement of the aim, such tasks are untied: the analysis of present methods of determination of losses of balance-industrial supplies and impoverishment of content of quality indexes of minerals; the improvement of existent methodologies of determination of losses of balance-industrial supplies and impoverishment of content of quality indexes of minerals taking into account the complex mastering of bowels of the earth; the establishment of norms of losses of balance-industrial supplies and impoverishment of content of quality indexes useful minerals. The idea of work is analysis and determination of methods of calculation of optimal losses for development of economy of ore-mining enterprises and indexes of plenitude of the use of resources of bowels of the earth at present labor and material resources.

Basic indexes of the use of supplies of bowels of the earth are losses of balance-industrial supplies and impoverishments of content of quality indexes of minerals in an array and in the stream of iron-ore mass. In quality of indexes to them reciprocals – coefficient of exception of minerals from the bowels of the earth and coefficient of changeability of content of quality indexes of minerals are accepted at the booty of balance-industrial supplies. These instructions are obligatory leading materials at planning, building and exploitation of all ore–mining enterprises. In this connection will bring only generals over on an account, estimation and setting of norms of losses of balance-industrial supplies and impoverishment of content of quality indexes of minerals in iron-ore mass with some working out in detail of the surveyor providing of works at working mine of hard minerals, in particular taking into account the complexity of the use of the bowels of the earth.

For correct determination of losses of balance-industrial supplies and impoverishment of content of quality indexes of minerals in iron-ore mass, the same as indexes of exception from the bowels of the earth and changeability of content of quality indexes of minerals of iron-ore mass, value has a choice of method of the surveyor providing of works, that most full answers that is why or to other type of minerals. The indexes of losses of balance-industrial supplies and impoverishment of content of quality indexes of minerals are needed for the decision of economic tasks in iron-ore mass must take into account not only content of quality indexes of minerals, lose that impoverishing breeds, but also where and on what stage of the survey or providing of project mountain works lose these minerals and impoverish. Only classification of losses of balance-industrial supplies of hard minerals, built because of division on the technological processes of booty and places, where losses of balance-industrial supplies are.

This classification is given for all methods of development and all hard minerals. Taking her for basis, will consider the types of the surveyor providing of works on determination of losses of balance-industrial supplies and impoverishment of content of quality indexes of minerals in relation to the terms of development of iron-ore deposits. Under the losses of balance-industrial supplies mean that part of balance supplies that do not withdraw, and under impoverishment of content of quality indexes of minerals is a decline of content of quality indexes useful to the component in digging in comparing to his content in the array of balance supplies.

Subdivide the losses of balance-industrial supplies into the losses of balance-industrial supplies in guard that does not withdraw even after liquidation of ore-mining enterprise and if barrier temporal in some period of time envisage their partial or complete exception, then minerals in that does not attribute to the losses of balance-industrial supplies, but set off to the balance supplies) the operating losses of balance-industrial supplies(quantitative and quality), that is related directly to the booty of balance-industrial supplies, as they largely differ in technological reasons and places of their formation.

UDC 622.1

V.I. KAMENETS, PhD (Engineering), Associate Professor,
V.O. EPSHTEYN, student,
Y.O. CHERMAN, student,
Donetsk National Technical University, Ukraine

**SURVEYING SUPPORT OF THE UNDERMINING
OF TRANSPORT FACILITIES AT PJSC
“SHAKHTOUPRAVLINNYA “POKROVSKE”**

Intensive development of mining operations on the d₄ coal seam in blocks 10 and 11 of PJSC Shakhtoupravlinnya Pokrovske requires the improvement of surveying support for the undermining of transport facilities. One of these facilities is unique main conveyor MRC Cable Belt. It was built in 2011 according to the project of the company METSO Minerals between the skip shaft №2 of the mine and the processing plant of the concentrating factory "Svyato-Varvarynska". General Designer is PJSC "Luhanskkiproshakht".

The conveyor has three turning sections with a small turning radius for such objects (440 meters), therefore, high demands are placed on the conveyor foundation blocks installation accuracy. The error in determining the coordinates of the centers of the foundation and elevations should not exceed ± 6 mm, along the entire length of the conveyor, whose length is 5200 meters (660 foundation supports) and two bridge transitions.

In percentage terms, the coal strata along the conveyor route is distributed as follows according to lithotypes:

- mudstones and siltstones - 64-72%;
- sandstones - 26-33%;
- limestone - 1.0 - 2.5%,
- coals and carbonaceous mudstones - 0,5-1,0%.

In the area under consideration, one coal seam d₄, having a simple structure, with a total capacity of 1.3-1.9 m, is of industrial importance. The average thickness of the coal seam over the section is 1,6 m.

The depth of the coal seam development in the area is 568-776 m. The average development depth is 672 m.

The cable-conveyor belt is located on the undermined areas of the earth's surface from the 1st and 2nd southern lava of block 8 (2002-2003), the 5th lava of the southern panel of block 8 (2013), in the zones of influence from the 1st southern lava bremsberg block 5 (2006), 1st - 3rd southern lavas block 5 (1999-2000), 4th - 8th northern lavas block 6 (1994-1999 year), 4th lava the central panel of block 8 (2007), the 4th southern lava of the central panel of block 8 (2009), the 5th and 6th southern lavas of the central panel of block 8 (2012), the 6th southern "bis" of the central panels of block 8 (2016).

Safe undermining depth according to the "Underworking Rules ..." is 1067 m. Mining protection measures, namely:

- excavation of coal with the laying of the developed space with complexes like "Titan", reduction of the extracted thickness of the reservoir;

- partial extraction of coal by area;

will not lead to the necessary reduction of ground deformations. Since the coal seam to be removed is well above the safe working depth, in order to protect the cable conveyor belt, it was necessary to leave the safety pillar of the coal. The axis of the conveyor has the form of a broken line with roundings, located diagonally and across the strike of the seam. The length of the safety pillar was supposed to be about 400 m. However, at present, the conveyor was undermined by several lavas with different parameters practically along the entire length of the route.

Therefore, the expected surface subsidence is determined from the condition of the absence of the safety pillar. The expected maximum subsidence of the earth's surface will be 2.19 m.

Along the conveyor route, annual repairs are carried out on the foundation blocks and water is pumped out of the formed recesses.

Another important facility that is subject to the harmful effects of undermining is the existing railway line.

Railway section 383 km PC0 + 50 m - 383 km PC8 + 25 m is located on the field of PJSC "Shakhtoupravlinnya "Pokrovske" and belongs to the Pokrovsk station. In total there are two first category railway tracks on the coal excavation area. Rational railway undermining scheme is established on the basis of comparison of the calculated indicators of deformation with allowable indicators in accordance with the "Rules of undermining ..."

The performed calculations allow to draw the following conclusions: for the railway section 383 km PC0 + 50 m – 383 km PC8 + 25 m, which is undermined by the 5th northern lava unit 10 of the d₄ strata, the calculated deformation rates and the daily velocity of sediments are satisfied with the required tolerances.

In accordance with clause 8.2 "Rules of undermining..."forgery of the railway line is allowed without the application of protection measures; the completion of the railway should be conducted under the control of instrumental observations for the shift and deformation of the railroad and the earth's surface from the beginning of tampering to the end of the shift process.

For this purpose, the laying of a mine surveyor observation station is foreseen; the time interval between instrumental observations during the shift process is set in accordance with Table. 8.2 "The rules of undermining..." and is 6 months for the first category railways.

However, in the case of the implementation of the project of building block 12, considered by the new investor of PJSC "Shakhtoupravlinnya "Pokrovske" - Metinvest Holding - the construction project of block 12, a railway line will be laid on the undermined area to transfer the rock mass from the skip shaft №4 site to the concentrating factory "Svyato-Varvarynska".

800 gondola cars will be purchased and the traffic along the branch will be very intensive.

Mine surveying support of mining operations in the enterprise should be optimized.

The experience of performing special surveying works shows that it is difficult for the mining services of mining enterprises to perform such works due to the lack of highly qualified personnel, appropriate equipment and rigging.

Such work should be performed by specialized outsourcing enterprises servicing large mining enterprises.

M. V. SHOLOKH, Cand. Sc. (Eng.), Associate Professor,
V. A. LITVINENKO, Student
Kryvyi Rih National University, Ukraine

INDEXES OF THE USE OF BOWELS OF THE EARTH ARE WITH TAKING INTO ACCOUNT OF SIBILANCE ON MAINTENANCE QUALITY INDEXES MINERALS OF SUPPLIES

Offered methodology of control of the use of found-balance and maintenance of balanced on maintenance quality indexes minerals of supplies, that is attracted in exploitation, calculations conduct that after formulas, that take into account the volume of useful components attract that with breeds and balance on maintenance the quality indexes of minerals of supplies, so losses of balance-industrial supplies of that or other part of found-balance supplies of deposit. If not to conduct the separate account of all sources of entering iron-ore mass of useful components, then throw away opportunity objective comparison of job performances for the improvement of the use of bowels of the earth of areas of arrays of hard minerals that are in different mining-and-geological terms.

The considered methods of the surveyor providing of works are on determination of volumes of crop and setting of norms of quality indexes of balance industrial supplies of bowels of the earth, in that examine the losses of balance-industrial supplies and impoverishments of content of quality indexes of minerals as the determined (non-random) sizes. The conducted review of methods and technical upshots will allow to bring down losses of balance industrial supplies and impoverishments) of content of quality indexes of minerals at a booty, ware housing and necessity of variegation of content of quality indexes of minerals in the stream of iron-ore mass. It is well-proven that for the correct choice of optimal (normative) the level of losses of balance-industrial supplies and impoverishment of content of quality

indexes of minerals in iron-ore mass in every concrete case of the use of criterion of estimation of economic efficiency, that full enough takes into account the difference of variants of development for operating and capital charges. The criteria of economic evaluation at setting of norms of losses of balance-industrial supplies are differential mountain rent and income.

Estimate rationality of process of mastering of mineral resources the indexes of plenitude of exception of them from the bowels of the earth and to the further processing. Therefore, the number of «passing» components withdraws that from complex mineral raw material increases continuously.

The aim of the work is the development and introduction of methodology of determination of losses of balance-industrial supplies and impoverishment of content of quality indexes of minerals taking into account the complex mastering of bowels of the earth. The idea of work is analysis and determination of methods of calculation of optimal losses for development of economy of ore-mining enterprises and indexes of plenitude of the use of resources of bowels of the earth at present labor and material resources.

Basic indexes of the use of supplies of bowels of the earth are losses of balance-industrial supplies and impoverishments of content of quality indexes of minerals in an array and in the stream of iron-ore mass. Determination of volume of losses of balance-industrial supplies and impoverishment of content of quality indexes of minerals in iron-ore mass matters for the decision ore-mining and economical and surveyor tasks. Foremost at a choice and comparison of methods and systems of development, determination of production capacity of mine (career), height of floor (to the ledge), estimation of balance-industrial supplies and establishment of standard on minerals, comparison of opening methods, determination of rational parameters of the systems of development and surveyor providing of technology of mountain works.

Characterize the losses of balance-industrial supplies an amount and quality of part of minerals that abandon in the bowels of the earth, in comparing to liquidate balance-industrial supplies. The

coefficient of exception of balance-industrial supplies from the bowels of the earth characterizes an amount and quality of the obtained part of balance supplies. If balance-industrial supplies are lost on content of quality indexes of minerals does not differ from the balance-industrial supplies of block determine their volume directly in the process of the surveyor providing of realization of mountain works in a coalface.

If not to conduct the separate account of all sources of entering iron-ore mass from the balance-industrial supplies of useful components, then lose another possibility of objective comparison of work for the improvement of the use of bowels of the earth of areas of arrays of hard minerals that are in the different mining (at presence of in the breeds of useful components and without them, at possibility of abandonment in the losses of balance-industrial supplies of poor on maintenance quality indexes minerals and without them) and geological conditions. In an order to take into account this important circumstance, some other factors (even partly), for example multicomponent of minerals and possibility of determination of losses of balance-industrial supplies at the surveyor providing of booty and complexity of the use of mineral raw material, it is expedient to replace an index - content of quality indexes of useful components (metals) by next indexes: Minerals, that withdraw the value of content of quality indexes in the balance supplies of u_{δ} ; In supplies, that lose u_n ; At impoverishing on maintenance quality indexes minerals breeds of u_p ; By a value on maintenance quality indexes in digging, that withdraw u_{δ} .

Experience of development of iron-ore deposits testifies that in many cases she indexes of the use of bowels of the earth are with taking into account of sibilance on maintenance quality indexes minerals of supplies is carried out in a few stages. On the measure of working off the richest deposits, beds, ore bodies or areas of array of hard minerals in exploitation attract more poor on maintenance quality indexes minerals. In a number of cases with high efficiency already work off deposits, beds, ore bodies or areas of arrays of balance-industrial supplies that yet recently distinguished as sibilance.

Section “Labor Safety”

UDC 519.714: 622.7

V.S. MORKUN, DSc. (Engineering), Prof., Vice-Rector for Research

N.V. MORKUN, DSc. (Engineering), Assoc. Prof.,

S.M. HRYSHCHENKO, PhD (Pedagogy),

Head of Postgraduate and Doctoral Studies Department, Kryvyi Rih National University, Ukraine

SYNTHESIS OF IDENTIFICATION ALGORITHMS OF STATIC AND DYNAMIC CHARACTERISTICS OF AUTOMATIC CONTROL OBJECT

Local automatic control systems (SAC) are a basic element of current automatic control systems of technological processes (ACS TP). Control algorithms used to synthesize these systems should take into account specific features of both a control object and means of acquiring input information. In case of changing and dynamic characteristics of the control object, automatic control systems should adjust their parameters to achieve high-quality control over the process. Efficiency of automatic control of processes in mining production can be enhanced by developing and introducing searchless jam-resistant algorithms of adaptation based on forming specified characteristics of transient processes in closed loop ACS.

To solve this problem, characteristics of the control object should be previously identified [1-3]. The automatic control system under analysis includes a proportional and integral controller (PI-controller) and an object, its transfer function being approximated by the first order relaxation circuit with time delay. The static factor of transmission K_0 and the time constant of the control object T_0 are defined by available results of measuring parameters of the automatic control system during its normal operation.

The unknown parameters are evaluated from the following algebraic equations

$$\sum_{i=0}^p a_i \lambda_i - b\Delta - b_0\eta = 0, \quad \sum_{i=0}^p a_i \delta_i - b(N+1) - b_0\Delta = 0, \quad (1)$$

$$\aleph_{ij} = \sum_{k=1}^{N+1} X_k^{(j)} X_k^{(i)}, \quad \delta_j = \sum_{k=1}^{N+1} X_k^{(j)},$$

$$\lambda_j = \sum_{k=1}^{N+1} X_k^{(j)} Y_k, \quad \Delta = \sum_{k=1}^{N+1} Y_k, \quad \eta = \sum_{k=1}^{N+1} Y_k^2.$$

where X is an output signal of the control object, Y is an output signal of the PI-controller, g is an impact value.

The given expressions indicate that factors a_i, b, b_0 are determined by means of the system parameters K_0, T_0, g

$$a_0 = \frac{1}{T_0}; \quad b_0 = \frac{K_0}{T_0}; \quad b = \frac{K_0 g}{T_0}. \quad (2)$$

Thus, identification reduces to finding parameters of equation (2) in which $Y(t)$ and $X^{(i)}(t)$ are measurable values.

After solving (1) and (2), we obtain the formulae for determining parameters of the control object

$$T_0 = a_0^{-1} = \frac{\lambda_0^2 - \aleph_{00}\eta}{\aleph_{10}\eta - \lambda_0\lambda_1}, \quad (3)$$

$$K_0 = T_0 b_0 = \frac{b_0}{a_0} = \frac{\aleph_{10}\lambda_0 - \aleph_{00}\lambda_1}{\aleph_{10}\eta - \lambda_0\lambda_1}. \quad (4)$$

The resulted expressions are used to synthesize algorithms of adaptive control over various mining objects, the static and dynamic characteristics of which vary widely. The industrial acceptance of the developed adaptive control algorithms reveals their potential to reduce dispersion of the controlled parameter by 15-20 % and duration of transient processes in closed loop automatic control systems by 20-30%.

References

1. Morkun V.S., Tsokurenko A.A., Lutsenko I.A. Adaptivnyie sistemyi optimalnogo upravleniya tehnologicheskimi protsessami. Krivoy Rog: Mineral, 2005, 261 p.
2. Morkun V.S., Tron V.V., Goncharov S.A., Podgorodetskiy N.S. Energoeffektivnoe avtomatizirovannoe upravlenie protsessom obogascheniya rudyi s raspoznavaniem ee tehnologicheskikh raznovidnostey. Krivoy Rog, 2014, 326 p.
3. Morkun V.S., Morkun N.V., Tron V.V. Optimalnoe upravlenie protsessom obogascheniya zheleznoy rudyi. LAP LAMBERT Academic Publishing, Saarbrücken, Deutschland, 2015, 310 p.

UDC 622.817

O.C. ALABA, PhD (Mining Engineering), Senior Lecturer,
Federal University of Technology, Akure, Ondo State, Nigeria

DESIGN OF AIR AND DUST QUALITY MEASUREMENT AND MONITORING DEVICE FOR MINERAL INDUSTRY

The annual hazard report of air pollution caused by dust and other harmful gases releases from mineral industries is no longer acceptable. It has rendered many versatile and experienced workers incompetent as a result of the effect of inhaling harmful gases and dust when they are working.

Many developing countries miners expose to serious harmful gases and dust during mining operations due to lack of device for detecting and monitoring gases and dust. The situation is pathetic as the government is making fantastic effort in diversifying the economics to solid mineral sector. The available air and dust detection and monitoring system used in most of developed countries are not easily accessible and also expensive for the local miners. On this regards, the study designed a cost effective air and dust monitoring device.

The device was developed with the aid of Arduino Mega 2560 which contains microcontroller board, 54 digital input/output pins, 16 analogue inputs of 4 UARTs, 16 MHz crystal oscillator, USB connection, a power jack, an ICSP header, and a reset button. MQ-7 carbon monoxide gas sensor with concentration detection between 20-2000ppm; MQ2 LPG, Propane and Hydrogen gas sensor with concentration detection between 300-10000 ppm; MQ135 ammonia, sulphide, benzene vapour and smoke gas sensor with concentration detection between 10-1000 ppm and dust sensor were incorporated with the microcontroller of the Arduino Mega 2560 board.

Also, a storage device was incorporated with the device for storing data. The device can be connected directly to PC via USB with a 6 V 4.5Ah rechargeable battery. The device was tested in both surface and underground mines while performance evaluations were carried out by comparing the results with other air and dust quality monitor.

The results shows that there is no significant different between their readings but it is very easy to operate and affordable to local miners due to very low cost.

N.A. DRIZHD, Dr. of Tech. Sciences, Prof.,
R.K. KAMAROV, Cand. of Tech. Sciences, Prof.,
A.E. ZHUMABEKOVA, PhD student,
Karaganda State Technical University, Republic of Kazakhstan

HYDROGEN AND SULFUR GAS EFFECT ON THE ENVIRONMENT

Hydrogen sulfide (H_2S) is a gas without color, with a sweetish taste and the smell of rotten eggs (its smell is felt when the content in air is 0,0001 %). Hydrogen sulfide irritates mucous membranes of the eyes and respiratory tract, as well as the nervous system. At a concentration of 0.01 % (0,14 mg/l) a person after a few hours gets a mild poisoning [1]. At a concentration of 0.02% (0,28 mg/l) there is a burning sensation in the eyes, photophobia, tearing, conjunctivitis, irritation in the nose and throat, metallic taste in the mouth, fatigue, headaches, chest tightness, nausea [1]. Exposure of 0.7 mg/l (0.05 %) for 15 to 30 minutes causes painful irritation, conjunctivitis, runny nose, nausea, vomiting, cold sweat, cramps, sometimes diarrhea, pain when urinating, shortness of breath, cough, chest pain, heartbeat, headache, feeling of clenching of the head, weakness, dizziness, and sometimes fainting. Longer inhalation can lead to bronchitis or inflammation and pulmonary edema.

When inhalation of 1,4 mg/l (0,10 %) and higher, poisoning can develop almost instantaneously: convulsions and loss of consciousness end with a quick death from respiratory arrest, and sometimes from heart paralysis.

The maximum permissible concentration of hydrogen sulfide in the mine atmosphere is 0,00071 % (0,01 mg/l) by volume, or 10 mg/m³ H_2S . The combustible concentration in the mixture with air ranges from 4 to 46 %, and the most dangerous - 12 %.

A large amount of material has been accumulated about the toxic effects of hydrogen sulfide on humans, causing acute poisoning, which is still found under production conditions.

When the concentration of hydrogen sulfide in the air is up to 100 mg/m³, there are apparently no noticeable effects; at 100-210 irritation of the eyes and mucous membranes of the nose and

pharynx; at 210-430 irritation of the eyes and mucous membranes of the nose and pharynx, effects on the central nervous system; at 430-710, subacute effects of poisoning: irritates the mucous membrane, affects the central nervous system, respiration, disturbed consciousness, etc., and in some cases, the onset of death within 30 minutes; at 710-1140 effects similar to those listed; additionally appear shortness of breath, loss of consciousness, convulsions, respiratory paralysis; at 1140-1990 apoplexy cramps, death within 1-3 minutes [2].

A special feature of the acute effects of hydrogen sulfide is that, at high concentrations, it makes the olfactory epithelium receptors insensitive. This is often the cause of numerous poisonings and deaths, and above all mass poisonings. At a concentration exceeding 280-430 mg/m³, the person no longer perceives the smell of hydrogen sulfide and therefore very often tries to find salvation where the concentration of gas has a toxic effect, i.e. it makes wrong decisions.

It is known that when the concentration of hydrogen sulfide is more than 0,0071 % by volume, i.e., with a 10 - fold excess of permissible norms, sulfur dioxide SO₂ can simultaneously be emitted. With the simultaneous presence of hydrogen sulfide and sulfur dioxide in the air, the toxicity of hydrogen sulfide in the mixture is significantly higher than in its pure form. The body cannot get used to the effects of hydrogen sulphide; on the contrary, its sensitivity after suffering mild poisoning rises even at low concentrations, poisoning occurs more quickly.

By toxic properties, hydrogen sulfide and sulfur dioxide are almost the same. SO₂ is colorless, has a sharp sour taste, very poisonous [1]. The toxicity of SO₂ is that, when dissolved in moisture, it forms sulfurous acid: SO₂+H₂O=H₂SO₃. Getting into the eyes, SO₂ erodes the mucous membrane of the eyes, dissolving in sweat, eats away the skin, gets into the lungs, eats away the lung tissue. With prolonged exposure, vomiting is also observed; vomit may contain blood. A single inhalation of very high concentrations leads to shortness of breath, cyanosis, disorder of consciousness. It is

usually considered that death occurs from asphyxiation due to reflex spasm of the glottis, sudden cessation of blood circulation in the lungs, or shock. Death can occur as soon after poisoning (in a few hours) - from pulmonary edema, and much later (from 20 days to 10 months) - from respiratory diseases.

Sulfur dioxide is palpable at very low concentrations in the air (0.0005 %) and is life threatening at a content of 0,05 % even with a short - term effect on the human body. When the content of SO₂ in the mine air is 0,0002 % (0,0006 mg/l), its smell is already felt. When the content of SO₂ is 0,0013-0,0021 % (0,040-0,60 mg/l), it is acceptable for a person to stay for 20-30 minutes. When the content of SO₂=0,0042 % (0,12 mg/l), staying longer than 3 minutes is life threatening, and finally, at a content of 0,05 % (1,5 mg/l), death occurs after several sighs.

In the case of chronic poisoning of a person with sulfur dioxide, the sense of smell worsens, taste perception decreases; there is a disease of the respiratory tract, less often - gastrointestinal disorders and conjunctivitis; decay teeth.

First aid in case of poisoning is artificial respiration on a fresh stream, inhalation of chlorine (for example, using a scarf moistened with bleaching powder).

The maximum permissible concentration of sulfur dioxide in the mine atmosphere is 0,00038 % (0,01 mg/l) by volume, or 10 mg/m³ H₂S.

Bibliography

1. Harmful substances in industry. V. 3: Chemistry. - L.: 1976. 389 p.
2. Kappus H. Toxicology of hydrogen sulfide (translated from German). - M.: 1980. 12 p.

I.I. CHOBOTKO, postgraduate of the department of mining machines and engineering of the National Technical University "Dniprovskaya Polytechnic", Dnipro, Ukraine

S.V. TYNYNA, candidate of technical sciences (Ph.D.), senior researcher in department of mechanics of elastomeric constructions of mining machines, M.S. Polyakov Institute of Geotechnical Mechanics NAS of Ukraine (IGTM, NAS of Ukraine), Dnipro, Ukraine

METHODS AND MEANS OF LOCALIZATION OF FOCALS OF SELF-IGNITION OF SPECIFIC DUMPS

Until recently, due to the quenching of waste heaps, due attention was not given. This led to their accumulation and as a result of the occurrence of emergencies associated with them, fires, etc.

The reason is the accumulation of excessive pressure inside the dump due to vapor separation, due to the oxidation reaction of compounds of pyrite and sulfuric anhydrite. This, in turn, provoked man-made disasters with catastrophic consequences.

For example: an explosion in a rock dumpster can lead to the dispersal of pieces of rock at a fairly large radius (up to 2-2.5 km), thus contaminating adjacent territories with settlements and leading to the death of people [1].

Were offered to prevent spontaneous combustion of waste heaps. These include:

- extinguishing with water;
- solutions and suspensions of hydroxides and carbonates Na, K, Ca.

The latter method has shown its significant efficiency. So on its basis were developed industrial technologies of quenching on dumps.

The high efficiency of using calcium hydroxide (quenched lime) to prevent spontaneous combustion is due to the peculiarities of the interaction of this substance with the solid and liquid phases of the oxidation-reduction reaction of pyrite, as evidenced by the research by leading scientists Zborschik M.P. and Osokin V.V.

Calcium hydroxide, whose dissociation temperature on CaO and H₂O is 540°C, can be used as a suspension for quenching mining

rocks. In this case, not only the cooling of the rock material, but also the absorption of emissions of harmful gases with calcium hydroxide from the ignition box [1,2].

In practice, suspended lime is used in the form of a suspension - limestone milk containing CaO by weight up to 10-15%. This ensures high efficiency of the localization of the interfacial space [1].

The chemical reactions with its participation proceed relatively quickly. When adding a limestone slurry to acid water, the process of neutralizing it and depositing available iron compounds takes place over a short period of time. Thus, there is a rapid binding of the interfractional space with the absorption of heat [2].

Due to the small amount of solubility of calcium hydroxide in water, during the work on the prevention of spontaneous combustion of rock, the greatest effect of changing the solid and liquid phase should be expected in the zones of filtration of the suspension. The efficiency of using a limestone suspension for the quenching of coal or coal-clay rocks is due to the endogenous action of the substance, the interaction of calcium hydroxide with a solid surface and the products of the oxidation-reducing reaction, as well as the reduction of gas permeability of the massif or rock [2,3].

Rock formation in flat dumps occurs due to the small thickness of the surface layer along their lateral surface. Prevent spontaneous combustion of the breed or extinguish it on the slopes of flat dumps may be the formation of a protective layer on their lateral surfaces, which prevents manifestations of thermal depression in the forming or existing cell of the exothermic process [3].

Deepening of the rock in dumps of various configurations can occur by pumping water with additives.

In this case, an integral part is the cooling of the combustion cell with a liquid, precipitation on the surface of the rock of the components contained therein, extrusion from the interfractional space of combustible gases, coagulation of harmful substances, neoplasms [3,4].

When choosing substances as additives to water, it is preferable to provide quenched lime as the most affordable, cheap and environmentally friendly material. In the metallurgical industry, lime is deposited on the lime kiln filters and is considered as a waste of production.

This lime can be used in the course of work on the prevention of self-ignition of rocky rocks and their quenching. From a practical point of view, the positive effect of preventing the burning of waste heaps is achieved when using a 3-5% limestone slurry [4].

The work of the device is as follows. In a mixing tank filled with technical water, loaded lime is loaded at a rate of 30-50 kg per 1 m³ of water. Inject into the dowel for the entire length of the injector and suction pipe.

Include a vacuum pump. Deleted from the waste gas go through perforated pipes in the bottom of the tank portion for mixing, while there is an intense mixing of quenched lime with gas streams and the formation of suspension.

This process is accompanied by the absorption of some of the gases removed from the dump, then a pressure pump is applied which, under pressure, feeds the limestone suspension from the mixing vessel to the 2-4 injectors introduced into the dump [4,5].

The effectiveness of this method is confirmed by many years of experience in the use of fire dumps.

Thus, the results presented in the article show the optimal choice of methods for preventing self-ignition of waste heaps using calcium hydroxide, which has universal possibilities to neutralize rock spontaneous combustion through endogenous influence on interfacial space with the absorption of thermal energy, which ensures the safety of the operation of dumps [5].

References

1. Chobotko I.I., Tynyna S.V. Bulletin of the National Technical University "KhPI". Series: Mechanic-technological systems and complexes. T 44. 2017 p. "Problems of operation and methods of prevention of burning of waste heaps" .P.-146-151.
2. Zborshik M.P, Osokin V.V. Burning of rocks of coal deposits and their quenching. - Donetsk: DonSTU, 2000.-180 p.
3. Zborshik M.P, Osokin V.V. Prevention of environmentally harmful manifestations in coal rocks. - Donetsk, DonSTU, 1996.-178 p.
4. Zborshik M.P, Osokin V.V. Coal of Ukraine 2015 The nature of spontaneous combustion and quenching of coal mines. P.-76-78.
5. Zubova L.G., Zubov A.R., Zubov A.A. Monograph. Slagheap. - Lugansk: Knowledge, 2015. - 712 p.

E. FILATIEVA, postgraduate student,

M. FILATIEV, candidate of technical science, Associate Professor,

M. ANTOSHCHENKO, doctor of technical science, professor
Volodymyr Dahl East Ukrainian National University, Ukraine

EFFECT OF THE SPEED OF MOVEMENT OF TREATMENT FACES (COAL MINING) ON THE GAS RELEASE FROM MINING SOURCES

At present, it is established that with the increase of the speed of movement of treatment faces (coal mining), gas release into both mining and degassing wells drilled into the roof to drip methane from worked-out sources increases. In the current regulatory document on the design of ventilation of coal mines, the impact of changes in the speed of movement of treatment faces on the level of methane release in the development of excavation sites is predicted by the ratio of the estimated coal production (A_p) to the actual (A_a) to the degree of 0,6. Influence of change of speed of movement of treatment faces (coal mining) on level of methane release from separate sources is not considered by the regulatory document. The study of gas release from working sources is relevant to ensure the safe mining of gas-bearing coal seams, as methane emission from these sources in many cases reaches 90% or more in the total gas balance of the excavation sites.

To establish the separate effects of the speed of movement of treatment faces (of the level of coal mining) to methane release into mine workings and degassing wells has been involved to analysis of experimental data obtained from the testing of the reservoir with the capacity ℓ_2^e of 0.9 m by mine of the name Newspapers "Izvestia" on 11 excavation sites. The average daily rate of movement of treatment faces varied in the range of 1,0-5,0 m. The levels of methane release into the outgoing ventilation air flow of the excavation sites (I_e), degassing wells (I_d^{ew} , I_d^{pw}) and their total gas release within the excavation sites (I_t) were taken into consideration during the period of reaching the maximum value after the precipitation of the main roof were taken into consideration. During this period of operation of

the cut-off areas, gas finding carried out by wells drilled over the cut-off mine workings under the protection of whole coals, the so-called end wells. Wells from the precinct workings were drilled besides these wells. To the correlation analysis of the dependence of methane release in the wells of these groups (I_d^{ew} and I_d^{pw}) from the speed of movement of treatment faces (v_f) also used their total values (I_d^t). As a whole the correlation coefficients (r) of dependence on v_f methane release in mine working (I_e), end wells (I_d^{ew}) drilled from the site workings (I_d^{pw}), their total value (I_d^t), as well as the total level of gas release within the excavation sites (I_t) are determined.

A high degree of tightness of the correlation from v_f is obtained for gas release (I_e) in the mine working ($r = 0.77$). This gas release formed under the influence of methane release from the beaten off coal, bare surface of the mine treatment faces and not degassed sources in the roof and the ground of the developed layer, exposed surface stope and nudehairy sources in the roof and the ground of the producing formation. Based on the physical representations of the gas emission from the beaten off coal and the bare face of the mine treatment face are directly related to the level of coal production.

Gas release from other sources (I_d^{ew}, I_d^{pw}) and their total components (I_d^t, I_t) only indirectly, through the processes of displacement of the worked rocks, depend on the speed of movement of mine treatment faces (coal mining). This was confirmed by the lower correlation coefficients for $I_d^{ew} - r = 0,53$, $I_d^{pw} - r = 0,58$, $I_d^t - r = 0,37$ и $I_t - r = 0,61$. The gas content of the developed formation (q) could supposedly effect this correlation. It was in the range $15 \div 35 \text{ m}^3/\text{t. d.}$ for different excavation sections. To reduce the impact of q on the results of correlation analysis, the values of I_e , I_t , I_d^{ew} , I_d^{pw} , I_d^t adjusted by the correction factor $K = \frac{q_i}{35}$. Depending on the actual gas content of the developed reservoir at each excavation site (q_i) the coefficient K was in the range of $1.00 \div 2.33$. The

correlation analysis conducted for dependencies $I_e \cdot K = f_1(v_{gf})$, $I_t \cdot K = f_2(v_{gf})$, $I_d^{ew} \cdot K = f_3(v_{gf})$, $I_d^{pw} \cdot K = f_4(v_{gf})$ и $I_d^t \cdot K = f_5(v_{gf})$. The introduction of the correction factor practically had not effect the change in the correlation coefficient ratio. For $I_e \cdot K$ - $r_1=0,79$, $I_t \cdot K$ - $r_2=0,46$, $I_d^{ew} \cdot K$ - $r_3=0,49$, $I_d^{pw} \cdot K$ - $r_4=0,49$, $I_d^t \cdot K$ - $r_5=0,23$. This indicates that the gas content of the developed layer does not have a significant influence on the methane release from the sources. To establish a more detailed effect of the speed of movement of treatment faces (coal mining) on the gas release from the worked sources, it is necessary to take into account the gas content of contiguous coal seams and the host rocks with a preliminary assessment of the amount of gas in the sorbed and free state.

UDC 629.039.58

L.D. TRETIAKOVA, Doctor of Technical Sciences, Professor,
L.O. MITIUK, Candidate of Technical Sciences, Associate
 Professor,

National Technical University of Ukraine “Igor Sikorsky Kyiv
 Polytechnic Institute”,

G. M. TOKAR, PhD student the Department of Ergonomics and
 Design of Clothing,

Kyiv National University of Technologies and Design, Ukraine

EVALUATION RISKS THAT OCCUR DURING THE USE OF PROTECTIVE CLOTHING FOR THE WORKERS OF THE MINING INDUSTRY

The main task of the process of designing the protective clothing (PC) depending on the certain working conditions is the choice of design and technological solutions in each design situation. In accordance with the European Directives, design and technological solutions for PC in the foreseeable operating conditions must, above all, provide ergonomic characteristics (that is, not to restrict the freedom of movement), the maximum possible level of protection, guaranteed lifetime, without creating additional risks for use.

The indicator of the “risk in use” was proposed as an integral criterion for assessing the effectiveness of a particular type of PC. The results of the risk assessment, provide an opportunity to identify the risk factors for damage to the workers’ health and to determine on this basis the priorities of activities, aimed at minimizing the risks. When identifying indicators for assessing the hazardous conditions, the purpose of risk assessment and management is achieved – the determination of the baseline and the establishment of an acceptable level of residual risk.

First of all, we define the basic risk that means the overall risk, which theoretically possible during the use of PC.

$$R_i = \sum_{i=1}^n P_i \cdot D_i, \quad (1)$$

where R_i - certain type of risk; P_i - probability of occurrence of i -th risk; D_i - consequences of occurrence of i -th risk.

The probability of the occurrence of risks for the worker’s health will always be a consequence of PC refuses; such kind of risk is associated with the receipt of injuries or diseases. For the risks associated with injuries or illness, quantitative estimates of the consequences are absent in most cases. Therefore, the paper assumes that the consequences of the i -th risk are equal to unit ($D_i = 1$) and the value of the basic risk is determined by the probability of occurrence of undesirable events.

After implementation of the planned activities, residual risk should be assessed, which is understood as the level of risk achieved through the introduction of additional measures. The level of residual risk is determined by the formula

$$R_{\text{зб}} = P_1 \cdot v_1 \cdot W_1 + P_2 \cdot v_2 \cdot W_2, \quad (2)$$

where P_1 – probability of loss of declared protective properties; P_2 – level of reliability; v_1, v_2 , – weighed coefficients of each component; W_1, W_2 - possibility of introduction of additional measures to improve the design and enhance operational safety.

Consider the effect of each factor f . (2) on the value of the basic risk. The first component is largely determined by the protective characteristics of the main and auxiliary materials. A quantitative assessment of the protective properties of protective clothing is proposed to be determined by the method of probit-functions, which

makes it possible to estimate the probability of trauma or disease of the worker under the influence of all available the hazardous and harmful production factors (HHPF).

The experience of calculations showed that it is effectually to use probit-functions with variable coefficients, the selection of which can approximate the real danger of the influence of various HHPF. The following analytic dependencies were selected for probit-functions

$$\begin{aligned} P_r &= a_i + b_i \cdot B_i^{c_i}; P_r = a_i + b_i \cdot (\ln B_i^{c_i}) \cdot \tau; \\ P_r &= a_i + b_i \cdot \ln(B_i^{c_i} \cdot \tau); \\ P_r &= a_i + b_i \cdot (\ln B_i^{c_i}). \end{aligned} \quad (3)$$

where a_i, b_i, c_i - coefficients that characterize the extend of the worker's injury from the certain i -th threat; B_i - indicator that characterize the harmfulness degree of the certain HHPF; τ - duration of the influence.

Coefficients a, b, c characterize the level of harm to the i -th factor and allow to determine the effectiveness of implementation of the measures, aimed to improve the protective properties of PPE: when coefficients have the lower values, less protective measures, aimed to ensure the residual risk, are needed. Indicator B shall be determined in accordance with the sanitary-hygienic limitations in force. For example, in case of the chemicals exposure – according to the excess of the maximum permissible concentrations of harmful substances. According to the microclimate indicator, taking into account the category of labor intensity – according to the level of the energy consumption. After determining the value of the corresponding probit-function, it is possible to calculate the probability of the occurrence of hazards, using the Gauss function.

The second component of the basic risk in f. (2) is determined by the level of reliability of the protective product. Construction of the model and justification of reliability indicators are made based on the results of statistical studies of the duration of use of certain types of PC.

The analysis of constructive and technological implementation of the protective clothing before the regular works made it possible to justify a consistent model in the form of a structural scheme of functional integrity with n simple elements.

The fail-free operation of the mean $P_3(\tau)$ in time is a product of the probability of fail-free operation of each of n -elements

$$P_3(\tau) = \prod_{i=1}^n P_i(\tau) = \prod_{i=1}^n [\exp(-\lambda_i \tau)] \quad (4)$$

where $P_i(\tau)$ is the function of reliability of the i -th element; λ_i is the intensity of failures of the individual element.

The proposed conceptual approach has sharply increased the requirements to the depth and the level of monitoring of the level of risk in the use of PPE at all stages – design, manufacturing, operation, utilization. Numerical values of the level of risk for each component make it possible to determine the sequence of the introduction of individual elements of transformation into the internal structure of protective products and to develop effective protective sets of PPE for performing of the work in certain hazardous working conditions.

UDC 622.807: 621.928.9

M.V. KHUDYK, PhD (Engineering), Senior Lecturer
Kryvyi Rih National University, Ukraine

WAYS TO INCREASE THE EFFECTIVENESS OF DUST CAPTURE BY DUSTING CHAMBERS

Most of the technological processes of industrial processing of minerals (iron ore, coal, granite, etc.) is accompanied by the formation of dust (classification by size, crushing and disintegration, transportation, washability). As a result of contact with the human body, industrial dust can cause various diseases (allergic reactions, cataracts, pneumoconiosis). In order to reduce the dustiness of air in industrial premises, dust extraction sites are localized with the help of aspiration shelters with the removal of dusty air into dust treatment plants.

In aspiration shelters of technological equipment for the processing of iron ore, air pollution can be: at grinding – up to 350-400 mg/m³; when crushing in jaw crusher – up to 900-1000 mg/m³, in a cone crusher – up to 700-800 mg/m³; when working mills – up to 90-120 mg/m³; at work of dry magnetic separators – up to 150-200

mg/m³; in case of overloading from conveyors, feeders, screens – up to 500-600 mg/m³, from crushers – up to 3000-5000 mg/m³.

Cleaning of aspiration air from dust occurs in dust collecting devices of different design and depends on the properties and value of the dust collected, the required degree of purification, the temperature of the air being cleaned, etc.

The dusting chamber is the simplest dust removal device in which the air flow is pollinated with low velocity, which results in the gravitational deposition of dust particles.

The advantages of dusting chambers are: simplicity of construction and operation; reliability and durability; possibility of arrangement with other elements of aspiration systems and possibility of application in both stationary and mobile installations; insignificant hydraulic resistance (up to 200 Pa).

Disadvantages of dusting chambers are: low efficiency of precipitation of fine fractions of dust from the gas or air mixture; large overall dimensions at high air flow; catching predominantly heavy and large particles.

The geometric dimensions of the dusting chambers determine the time of the flow of polluted air in them.

The dimensions of the empty dusting chambers are determined based on the given air flow and the minimum size of the particles to be caught. The ratio of length and height of the camera is determined by the ratio of the velocity of the polluted air flow and the rate of soaring (sedimentation) of the particle. Moreover, the smaller the velocity of the motion of the polluted air flow and the height of the dust removal chamber and its length, the smaller the rate of soaring (sedimentation) of the particles, that is, the smaller particles can settle in the chamber.

Dusting chambers should be used at the first stage of purification of gas or air for deposition of large and heavy particles.

The calculation of the size of the dust extraction chamber is reduced to the determination of the area of precipitation of dust particles, that is, the area of the bottom of the chamber and its walls. In this case, take a number of assumptions: the dust is evenly distributed over the section of the chamber, both in concentration and in dispersion; the dust consists of spherical particles, the sedimentation of which is completely subject to the Stokes law; the

speed of the air through the section of the chamber is taken uniform; the result of the convection flow and the turbulence of the air flow to the dust particles is zero; settled dust does not come from the camera.

The efficiency of catching dust particles with the help of gravitational sedimentation in the chambers can be increased by reducing the height of their fall. This can be done by placing a horizontal or sloping plate (shelf) into the cavity of the dust exhausting chamber, which transforms it into a group of small parallel chambers.

It is also possible to reduce the height of the fall (sedimentation) of dust particles by placing in the middle of the chamber special guide plates to direct the polluted air flow to the bottom of the dust removal chamber and to reduce the speed of its movement. By reducing the air velocity and the downward deviation of dust particles, due to collision with the guide plates and with each other, they coagulate forming aggregates that are better settled under the action of gravity.

In some designs of dusting chambers the equipment of chain or wire curtains and deflecting partitions, vertical or horizontal screens is foreseen to increase their efficiency. This allows, in addition to the gravitational effect, to use the effect of inertial sedimentation of dust particles in the flow of air through various obstacles.

In addition to the above methods, it is possible to increase the efficiency of dust clearing of dusting chambers by changing the parameters of dust particles. According to Stokes's law, the rate of soaring (sedimentation) of a dust particle is directly proportional to the square of its radius. Thus, when aggregating the particles, it is possible to achieve an increase in the speed of their soaring (sedimentation) and to increase the efficiency of the chamber at its constant geometric dimensions.

One of the ways of coagulating dust particles is the placement of various obstacles in the flow of dusty streams that create an electrostatic effect in the flow of air moving in the chamber, for example, the fibers curtain of nylon and polyvinyl chloride. In addition to the electrostatic effect on the dusty flow, the fiber curtains contribute to the mechanical coagulation of particles, as well as dust emissions due to the loss of energy of the moving dust particles during its impact on the fiber. Dust particles pass between

fibers and, coagulating on them, under the action of gravity, settle down to the bottom of the chamber.

On the basis of the research of various designs of dusting chambers it can be concluded that it is expedient to develop a new design of a dusting chamber of high efficiency with spaced-in cells in the middle of the chamber with nylon and polyvinyl chloride filtration for the purification of aspiration air in order to improve the sanitary and hygienic working conditions of the workers of the ore dressing mills and the mines.

UDK 622.411.332

O.A. OLEYNICHENKO, postgraduate student, Senior Lecturer

E.M. FILATYEVA, postgraduate student, Senior Lecturer

V.M. SOKOLENKO, PhD in Technical Sciences, Associate Professor

V. Dahl East Ukrainian National University, Ukraine

INFLUENCE OF FACE ADVANCE RATE ON OUTGASSING TREATMENT IN DEGASSING SYSTEMS

The productivity of degassing systems plays an essential role at the increase of face advance rate on the increase of gassing in mine openings and boreholes. Efficiency of degassing of the tapped sources at growth of face advance rate can both increase and diminish [1]. For example, at a flow of degassing system $70 \text{ m}^3/\text{min}$ and increase of face advance rate from 2 to 5,3 m per day of the 2nd western longwall face l_2^B of mining plant named after the newspaper “Izvestiya” has led to common (cumulative) gassing from 20 to $55 \text{ m}^3/\text{min}$, the amount of coopted methane increased from 10 to $40 \text{ m}^3/\text{min}$. Efficiency factor of degassing witnessed an increase from 55 to 70%.

When in operation the 6th panel longwall face l_7 of mining plant number 13-bis, the flow of degassing system did not exceed $10 \text{ m}^3/\text{min}$. Rate increase of face advance from 1,8 to 5,6 m per day was associated with the growth of methane release out of tapped sources from 3,5, to $17,5 \text{ m}^3/\text{min}$. The flow of methane deviated by the

boreholes increased from 1,6 to 5,0 m³/min, the efficiency of degassing diminished from 50 to 24%.

Using experimental data [1] a variation of average amount of methane [J_i] deviated by degassing systems of these working areas at fixed face advanced rates 2, 3, 4 and 5 m per day have been considered (Table 1).

Table 1
Experimental data of average methane flow in boreholes at fixed face advanced rates

Face advance rate, v_i m/per day	Methane flow, J_i m ³ /min	Variation v_i and J_i in relation to v_z and J_z		Variation v_i and J_i in relation to v_z and J_z		Variation v_i and J_i in relation to v_4 and J_4		Variation v_i and J_i in relation to v_5 and J_5	
		v_i/v_z	J_i/J_z	v_i/v_z	J_i/J_z	v_i/v_4	J_i/J_4	v_i/v_5	J_i/J_5
Mining plant named after the newspaper "Izvestiya", 2nd western longwall face									
$v_2=2$	$J_2=10,0$	1,00	1,00	0,67	0,53	0,50	0,36	0,40	0,27
$v_3=3$	$J_3=18,8$	1,50	1,88	1,00	1,00	0,75	0,67	0,60	0,51
$v_4=4$	$J_4=28,0$	2,00	2,80	1,33	1,53	1,00	1,00	0,80	0,75
$v_5=5$	$J_5=37,2$	2,50	3,72	1,67	1,98	1,25	1,33	1,00	1,00
Mining plan number 13-bis, 6-th panel longwall face									
$v_2=2$	$J_2=1,6$	1,00	1,00	0,67	0,55	0,50	0,44	0,40	0,37
$v_3=3$	$J_3=2,9$	1,50	1,81	1,00	1,00	0,75	0,81	0,60	0,67
$v_4=4$	$J_4=3,6$	2,00	2,25	1,33	1,24	1,00	1,00	0,80	0,84
$v_5=5$	$J_5=4,3$	2,50	2,69	1,67	1,48	1,25	1,19	1,00	1,00

Processing experimental data (Table 1) of constraint $J_i/J_i = \varphi(v_i/v)$ showed high closeness of correlation relationship for conditions of both mining plants.

Empirical dependence at high volume of gas in mine working area as well as sufficient flow of degassing system under the conditions of mining plant named after the newspaper "Izvestiya" was described by parabola $J_i/J_i = \varphi(v_i/v)^{1,4}$ correlation ratio (R) made 0,99.

In the conditions of mining plant number 13-bis at the small flow of the degassing system the equalization $J_i/J_i = \varphi(v_i/v)^{1,1}$ at $R = 0,98$ corresponded to this dependence.

Closeness of the obtained dependences at different volume of gas of mine working areas and the flow of degassing systems testify the closeness of processes of moving of the tapped breeds in the considered cases.

References

1. Kasimov O. I. Vliyanie skorosti podviganiya ochestnyih zaboev na effektivnost degazatsii podrobotannyih plastov / O.I. Kasimov, N. I. Antoschenko // Sb. Nauchnyih trudov MakNII Sposobyi bezopasnogo vyideleniya vzryivnyih rabot i borba s vyibrosami v ugolnyih shahtah – Makeevka – Donbass – 1983. – s.58-64.

Section “Mineral Processing”

UDC 622.776

V.N. KUVAEV, Dr.Sc.(Tech.), Prof.

I.K. MLADETSKY, Dr.Sc.(Tech.), Prof.

Ya. G. KUVAEV, Cand. Sc. (Tech), assoc. prof.,

NTU “Dniprovska Politehnika”

THE IMPORTANCE OF THE MINERAL DEMAGNETIZATION AT SEPARATION

Analysis of the papers on the magnetic separation of minerals during ore dressing shows that this process is good at cleaning waste from a valuable mineral. As for the enriched product, the primary separation (with the initial content of valuable mineral <50%) gives a significant increase in quality. Since the open valuable mineral is not extracted from further processing, the initial content of the valuable mineral in stages increases all the time and due to flocculation the capture of the non-metallic phase also increases all the time. Further, without the use of special methods, it is not possible to remove these particles from the concentrate mass, since the probability of the open non-metallic particle extraction asymptotically tends to zero. Thus, to obtain pure magnetite concentrates by currently used magnetic methods is a theoretically impossible event. Let's consider some special methods of magnetic separation, which contribute to obtaining pure concentrates.

Selective flocculation can be accomplished by slowly introducing a stream of ferromagnetic particles into a magnetic field of slightly increasing intensity. First, rich magnetite particles are magnetized and united into aggregates, moving to an area of elevated field gradient. After that, these units must be removed from the stream. Then the rich aggregates join. They should also be removed from the stream. Thus, selective flocculation can ensure the separation into several products of gradually decreasing quality. The necessary condition for such a

process is reducing all particles to zero residual magnetization, i.e. before separation - to demagnetize.

For the flocculation rate estimation, it is necessary to consider the movement of magnetite-containing particles towards each other under the action of their secondary magnetic fields for the condition that the external magnetic field is alternating. As a result, the equation of flocculation velocity is obtained

$$U = A / (B^2 + \omega^2) \cdot (\omega \cdot \exp(-B \cdot t) + B \cdot \sin \omega t - \omega \cdot \cos \omega t).$$

The study of this expression under these conditions

$H_0 = 10^4 m$, $d = 10^{-4} m$, $\kappa_1 = \kappa_2 = 5 HC units$, $r_{12} = d$, $B = 450$, $A = 8125$ gave the results shown in Fig.1.

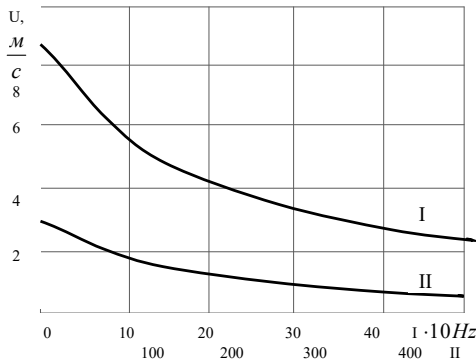

Figure 1 - Dependence of the flocculation rate on the frequency of the external magnetic field

Research results show that, with an increase in the frequency of the magnetic field, the flocculation rate decreases.

On the particle surface, the magnetic field increases compared with the external magnetic field in proportion to the magnetic susceptibility of the particle. And with the removal along the normal to the surface, it decreases in proportion to the cube of the distance and at a distance of two particle diameters it falls almost to zero (secondary field). I.e at this distance, the particle does not affect the

external field; therefore, the particles do not interact with each other when the distance between them is four times of the particle diameter.

The distance between particles in the pulp depends hyperbolic on the volumetric content of the solid. The density of the pulp is expressed by the volumetric and mass content of solid as

$$\delta_{II} = \delta_T \cdot \delta_B / (\delta_T - p_T \cdot (\delta_T - \delta_B)) \quad \delta_{II} = \delta_B + p_0 \cdot (\delta_T - \delta_B)$$

Solving these two equations together, we obtain the desired value of the solid content and the pulp density for the required distance between the particles: $p_0=0,0052$. In order to ensure such a solid content, it is necessary that the water Q_b is 57 times greater than the consumption of solid Q_T . It is impossible to realize such a condition for separation, and it is unacceptable. We estimate flocculation in weak fields.

In order the particle would be extracted or remain in the magnetic field, it is necessary that the magnetic force F_M is equal to the force of gravity $F_M=Fg$. That's why, the field strength with the magnetic susceptibility is $k=10$ units MS and $H=10200$ A/m. In such a field flocculation is greatly expressed. Floccules can be destroyed by flow turbulence σ . The pressure of turbulent pulsations is described by the value of $F_U = -0,75 \cdot \delta_B \cdot C_{\mathcal{I}} \cdot \sigma^2 / (\delta_B \cdot d)$ $C_{\mathcal{I}}=0,6$ - drag coefficient. At a flow rate of 1 m/s the turbulence is 0,1 m/s, then for $d=0,08$ mm $F_U = 6,2 H/kg$. Such a force is not able to break the floccules.

So, it is impossible to selectively realize flocculation or to get rid of it, as well. Therefore, before any separation operation it is necessary to apply demagnetization of particles and to create conditions for a uniform distribution of particles in the pulp volume.

UDC 65.011.56: 622.7.05

M.R. SHAUTENOV, Professor,
G.E. ASKAROVA teacher,
M.E.NURDAN, student ,
Satbayev University, Kazakhstan

ENRICHMENT OF SULFIDE COPPER-MOLYBDENUM ORE AND PRODUCTION OF COLLECTIVE COPPER- MOLYBDENUM CONCENTRATE

Copper-molybdenum ore of the East-Kounrad Deposit of copper-molybdenum ore selected from mine № 6 was presented as the object of research.

The maximum size of a piece of the selected ore sample was 180 mm.

Ore preparation was carried out mechanically on jaw and roller crushers and disk eraser, with the obligatory observance of the four - stage cycle: crushing, sieving, mixing by the ring-cone method and reduction on the Johnson divider.

The final diameter of the sample particles sent for analysis is 200 mesh, or 0,074 mm.

For the purpose of disclosure of useful components of ore from rock minerals at carrying out flotation processes of enrichment it is necessary to carry out process of crushing of the studied sample of ore.

The choice of this size class (65% of the class - 0,0074 mm) during grinding is associated with the over-grinding of molybdenum mineral.

During the molybdenum flotation of the collective copper-molybdenum concentrate, the second stage of grinding will be carried out during the selective flotation of ore.

Further, studies were carried out on the flotation enrichment of the studied ore sample to obtain a collective copper-molybdenum concentrate.

Adopted by the reagent flotation mode: in the grinding process was applied lime (CaO) to create a pH equal 10,0; sodium sulfide (Na₂S) for the sulphidation minerals.

In the loop collective copper-molybdenum flotation filed gatherers (kerosene, butyl sodium xanthate), Frother T-80, liquid glass

(Na_6SiO_3) to suppress gangue. Reagent consumption: kerosene-200 g/t (2 drops); butyl xanthogenate - 120 g/t (12 ml); T-80-90 g/t (9 ml); Na_6SiO_3 - 350 g/t (35 ml). The time of flotation 17-18 minutes. The content of the solid phase supplied to the flotation cell is 30% i.e. 1 kg of flotation on-one experience.

On the basis of this technological scheme from the collective copper-molybdenum concentrate can be obtained selective copper and molybdenum concentrates with high concentrations of copper and molybdenum.

The molybdenum content in the collective concentrate is on average 5,2%. The recovery of molybdenum in the collective copper-molybdenum concentrate is on average 5,2%. The recovery of molybdenum in the collective concentrate is 11,5%. The molybdenum content in the collective copper-molybdenum flotation tailings is 0.14%.

References

1. Goden A.M. Flotation, Moskow, Gosgortekkhizdat, 1959, p. 653. (in Russian).
2. Bogdanov O.S., Maksimov I.I., Podnek A.K., Yanis N.A. Theory and technology of flotation of ores, Moskow, Nedra, 1990, p. 363. (in Russian).

UDC 001.57:681.5.015: 681.542.35

A.N. MATSUI, PhD, Associate Professor

V.A. KONDRATETS, ScD, Professor

Central Ukrainian National Technical University, Kropyvnytsyi,
Ukraine

ANALYSIS OF THE OPERATION OF A MECHANICAL SINGLE-SPIRAL CLASSIFIER AS A CONTROL OBJECT

Iron ore concentrates produced in Ukraine lose on the international market because of a somewhat overestimated prime cost compared to their foreign counterparts. One of the factors for improving this indicator can be the improvement of the single-helical mechanical classifier 1KCH-30, which became widespread in closed grinding cycles of the original ore in the first stages of the ore-dressing plants and does not provide sufficient separation of finished

and undersized products, which leads to a significant electricity overspending and useful components loss.

The aim of the work is to analyze the operation of the classifier as a controlled object in order to identify ways to improve the supervision of technological processes in it.

Spiral classifiers are mainly used to produce relatively large sinks from 0.8 to 0.1 mm. The separation efficiency in them is 35 ... 65%.

The capacity of the spiral classifier and the separation size are determined mainly by the area of the pulp mirror in the processing unit and the sedimentation rate of solid maximum particle size, sent to the discharge. The sedimentation rate of solid particles depends on the density of the pulp in the classification zone. The thicker the pulp, the greater its viscosity and the lower the sedimentation rate of particles of a given size. Therefore, the density of the classifier drain associated with the density of the pulp in the classification zone is the main factor for the operational control of the operation of these units. By changing the water supply to the classifier, it is possible to influence the density of the pulp in the drain. The classification results are also influenced by the ore characteristics, especially the content of clay components, which increase the viscosity of the pulp and reduce the sedimentation rate of solid particles. This process is also influenced by the dactantation action of the classifier mechanism and the temperature of the pulp, which can vary within fairly wide limits, both because of seasonal characteristics and the pulp heating in ball mills during ore grinding. The main factors affecting the finished product are the discharge size, the fine fractions content, the source material density and the type of ore or mixture of ores.

Traditionally, the spiral classifier regulates the density of the pulp in the stream by supplying water to its bath. However, the regulation of the amount of water supplied to the classifier cannot stabilize the closed cycle of the mill-classifier, since the control is carried out with a large transport delay, and the change in the particle size distribution of the pulp at the inlet is stochastic.

The way out of this situation is mainly looking for practices, offering different approaches. For example, the method of deprivation of enlargement of a spiral classifier discharge was found experimentally by a cascade increase in the height of individual zones of the drain threshold. At the same time, the circulation load

increased from 231,8 to 265,5%, the specific productivity of the mill in the particle size less than 0.071 mm from 1,61 to 1,73 t / m³ g; classification efficiency from 35,5% to 54,8%. As can be seen, tangible results have been obtained. So, it can be argued that the technological regulation by the spiral classifier in the manual mode is quite a challenge and has relatively low performance even in the case of experienced operators. Therefore, in parallel, a certain work was carried out on the development of automatic controls.

It has been established that the mechanical spiral classifier is a nonlinear controlled object, however, linear approaches and the principle of control by deflection were used for it, despite the large delays and time constants. Considering the imperfection of such control systems, the poor quality of separation of the finished product from the large one and the low classification efficiency were obtained.

This state of affairs has developed due to the unsatisfactory character of the classification theory in mechanical spiral classifiers. The well-known theory of mechanical classifiers, proposed in the early 60s of the last century by Olevskiy V.A., is too simple. According to it, the separation of particles by size is due to the different speed of their fall in the pulp. Small particles of solid do not have time to fall below the level of the drain and are carried away by the flow, while the large ones fall to the bottom. However, for a number of reasons, this theory turns out to be quite unsatisfactory. The conclusions that follow from it often conflict with experimental data. For example, according to this theory, the separation of particles of solid size should be sharp, while in fact it is blurred. According to the theory, there should be an increase in size in the sink with increasing flow velocity, and in practice this relationship turns out to be the opposite, etc. An attempt has been made to develop a structural scheme of the spiral classifier, but due to imperfections, it does not give positive results and needs to be improved. Despite this, it is necessary to revise the basic theoretical background of the theory of mechanical spiral classifiers. More attention needs to be paid to the dynamic equilibrium between mixing and gravitational precipitation of solid particles. Since mixing is a significant factor causing a decrease according to experimental data on the size of the drain when the density

decreases, in theory, to obtain the qualitative and quantitative characteristics of the classification process, this section should be introduced. Considering that in the practice of ore dressing, the choice of the intensity of mixing and the height of the drain threshold is made during the classifier tuning, it is necessary to provide for the possibility of certain changes in the design of the spiral classifier.

Attention should also be paid to changing the principles of control of a mechanical spiral classifier in order to improve the quality of operation of a technological unit, which operates in difficult conditions of changing hydraulic characteristics with large delays and time constants. The prospect of further development is the creation of certain theoretical positions and the improvement of control systems for the mechanical spiral classifier.

UDC 622

W. BLASCHKE, Prof. DSc. PhD. Eng., Full Professor,
I. BAIC, DSc. PhD. Eng., Associate Prof., Branch Director,
Institute of Mechanised Construction and Rock Mining—Branch in
Katowice, Poland

DRY DESHALING OF COKING COAL BEFORE ITS ENRICHMENT IN JIGS

In every coal mine in Poland, underground extraction of coal are conducted in numerous fronts located in several coal seams. This is caused by mining and geological conditions. Deposits are cut by numerous faults.

For this reason, panel lengths are quite short. It is necessary to launch many extraction fronts in order to maintain the coal production at the required level. These coals differ in quality parameters. The thickness of seams is variable.

This results in cutting the roof or floor. The excavated material contains large amounts of gangue reaching even several dozen percent. During the transport to shafts, these coals are mixed in random proportions. This material is directed to coal processing plants.

Variations in the feed quality, and in particular in the variable in time amount of gangue, cause disturbances in the separation processes of the excavated material into concentrate and tailings. This phenomenon occurs mainly during the enrichment in jigs, even in those equipped with very good systems of the automatic adjustment of separation density.

Variations in the quality of coking coal concentrates make the preparation of stable inputs for coking processes difficult.

This complicates obtaining the stable quality of coke. A range of tests of the enrichment accuracy of two three-product jigs operating at one of the coking coal processing plant were conducted to examine the effect of the variable in time amount of gangue in the feed.

The examined jigs are equipped with the automatic adjustment of the collection of separation products. The enrichment accuracy was determined by the following coefficients: Ecart probable (E_p) and imperfection (I). The following results were obtained Ecart probable ranged from:

jig OM20-P3E - for degree I from 0,166 to 0,200 – on average 0,178, for degree II from 0.092 to 0,256 - on average 0,164,

jig OM24-D3E - for degree I from 0,249 to 0,304 – on average 0,271, for degree II from 0.138 to 0,274 – on average 0,214.

Values of Ecart probable of jigs with the automatic adjustment should range from 0.080 - 0,090.

Imperfection ranged:

jig OM20-P3E – for degree I from 0,196 to 0,244 - on average 0,217, for degree II from 0.196 to 0,365 - on average 0.274;

jig OM24-D3E – for degree I from 0,264 to 0,381 - on average 0,331; for degree II from 0.258 to 0,503 - on average 0,353.

The value of imperfection for jigs should range from 0,08 - 0,12.

The conducted tests showed unequivocally that the examined jigs operate with high inaccuracy.

The process proceeds in an unstable manner. The main reason for this are variations in the feed quality manifesting themselves in the variable in time content of gangue.

In Poland, there is no possibility to complement technological systems of coal processing plants with a classical averaging assembly due to their location near the shaft top.

The excavated material goes directly to the initial classification. Taking the excavated material outside the processing plant in order to average it is practically impossible due to the lack of space where this process would be conducted.

Further transport of the raw excavated material to the appropriate stacking yard and conducting the averaging process there and then introducing the averaged feed to the processing plant is a complicated operation with costs compared to costs of enrichment.

It is practically impossible to replace jigs with cyclones with a heavy liquid due to large variations in the amount of rock in the feed. Taking the relatively low accuracy of separation in jigs into account, authors believe that the introduction of stabilisation of the feed quality directly before its introduction into jigs would improve the quality of concentrates.

Authors propose the introduction of the averaging process of the feed in the enrichment assembly in jigs.

This can be solved by the application of dry deshaling on pneumatic-vibratory separators with air chambers of the FGX type verified in industrial conditions.

Authors conducted separation tests on particle size class 50 - 25 mm in an FGX 1 separator in two attempts. These attempts significantly differed in the ash content. Attempt I - 28.5%, and Attempt II - 37.8%.

The separation process was conducted with density above 2.00 g/cm³. After deshaling, products with a similar ash content - 19.9% and 18.5% were obtained. If these products were directed for the enrichment in a jig, the process should proceed in a more stable manner.

Obtained results allow us to conclude that the dry deshaling process can be utilised to average the feed before the enrichment process in jigs.

The authors proposed the introduction of the following solutions in the gravitational enrichment assembly. The excavated material directed to this assembly is separated into particles (plus 50 (30) mm)

subjected to enrichment in heavy liquids. Particle size class 50(30) - 0 mm is directed for the secondary classification, where particles 6 - 0 mm are partially screened. These particles are difficult to enrich in an FGX separator. Particle size class 50(3) - 6 mm is directed for deshaling in a pneumatic-vibratory separator with the air chamber. Rock, dust (from the dedusting process) and coal are separated. Coal is directed for the enrichment in jigs.

Rock is a commercial product. Dust can also be a commercial product or be an admixture to concentrates.

Averaging the feed through its deshaling will allow to improve the enrichment process in jigs. Coefficients of separation accuracy will be lowered. Losses of coal in tailings will be reduced.

Also, the contamination of concentrates by particles of gangue will decrease. Averaging the feed before enrichment in jigs will allow to obtain stable quality parameters of commercial products.

Proposed changes in the technological system of the enrichment assembly in jigs were submitted to producers of coking coal.

References

1. Baic I., Blaschke W., Sobko W. - Badania nad odkamienianiem energetycznego węgla kamiennego na powietrznych stołach koncentracyjnych. Annual Set The Environment Protection. Vol. 17. Middle Pomeranian Scientific Society of the Environment Protection. Koszalin. 2015 p. 958-972.[In Polish]
2. Mijał W., Blaschke W., Baic I., 2018 – Dry coal beneficiation methods in Poland. Proceedings of the 25th World Mining Congress. Astana. Kazakhstan. 2018
3. Okarmus P., Kowol D., Matusiak P., Łagódka M., Ziomber S.: Zwiększenie skuteczności wzbogacania węgla koksowych poprzez modernizację węzłów osadzarkowego wzbogacania. Monografia ITG KOMAG „Innowacyjne i przyjazne dla środowiska techniki i technologie przeróbki surowców mineralnych.2013, p. 159-166
4. Blaschke W., Baic I., Poprawa parametrów rozdziału węgla w osadzarkach poprzez wstępne uśrednianie nadawy metodą odkamieniania na sucho. Zeszyty Naukowe Instytutu GSMiE PAN Kraków nr 104, 2018 p. 163-172. [In Polish], DOI: 10.24425/124369

UDC 331.46925(043): 669.43.22

A.M. NIGMATULIN, Director, LLC «Kazakhmys Holding»
Kazakhstan,

A.N. KAN, Head of Directorate, LLC «Kazakhmys Corporation»,
Kazakhstan,

S.A. YEFIMENKO, PhD, Chief specialist LLC «Kazakhmys
Corporation», Kazakhstan

EFFECTIVE «ONLINE» ORE QUALITY CONTROL WITH THE HELP OF EDXRF ORE-CONTROLLING STATIONS ON THE CONVEYORS OF LLC «KAZAKHMYS CORPORATION» CONCENTRATE PLANTS AND MINES

The results of the research on arranging «online» control over the content of Cu, Ag, Pb, Zn, Cd, Fe in the ore, coming to Zhezkagan concentrate plants №1 and №2 from Zhezkazgan and Zhaman–Aybat fields with the help of three energydispersive X–ray fluorescence (EDXRF) ore-controlling stations (OCS) RLP-21T are stated in the reports [1,2] in detail.

But LLC «Kazakhmys Corporation» also includes the fields, developed by the mines of Karaganda and Balkhash industrial sites such as: Nurkazgan (Cu, Au, Ag, Mo, Se, S), Kusmurn (Cu, Zn, Pb, Au, Ag, Cd, Se, Te, S), Akbastau (Cu, Zn, Pb, Au, Ag, Cd, Se, S, Te), Abyz (Pb, Zn, Cu, Au, Ag, S, Se, Te, Cd, In, Hg), Sayak group (Cu, Mo, Fe, Au, Ag, Co, Bi, Te, Se, Re), Shatyrol (Cu, Mo, Au, Ag, Te, Se, U), and the concentrate plants of Balkhash (BOF), Karagajly (KOF) and Nurkazgan (NOF), which process these ores.

The ores of the mentioned fields are characterized by the compound material composition, very low (1+ppm) content of Ag, large quantity of technological sorts and are very difficult to be processed by EDXRF OCS.

Objectives of the research to be discussed:

– installation of OCS RLP-21T on heavy conveyors of BOF, KOF and on mainstream conveyors of the mine Nurkazgan underground (NPR);

– providence of the mines not only with the trustworthy and maximally full information about the element composition and content of the main and associated elements in the ores. Also providence with

the evidence base for the reason-based argumentation with regard to the quality of the delivered ores when distributing homogeneous metal of the concentrate plants at the end of calendar month.

The best practice of the world nonferrous metals industry does not have the examples of effective problem-solving of «online» control of the ores with regard to the content of main and associated ore components with ore granularity of - 300 mm and content of Ag and Cd 1+ ppm with the EDXRF OCS. Due to this, the set objectives are of great scientific and industrial interest.

The ores of the mines Konyrat, Sayak (mines Sayak-1 and Tastau), Shatyrkol, Nurkazgan, Akzhal and stocker slug of Balkhash smelter (BMZ) go to BOF. The ores from the mines Akbastau, Kusmuryan and Abyz go to KOF. Ores, extracted from NPR, goes to NOF.

The most difficult analytical challenge was supposed to be solved at BOF, where it was necessary to simultaneously test in «online» mode both heterogeneous objects - ores from the fields and actual homogeneous objects - stocker slug of Balkhash smelter. The ores were represented by the whole palette of copper content: high (Shatyrkol), average (Sayak 1, Tastau, Nurkazgan), low (Konyrat) and very low (Akhal). The stocker slug of Balkhash smelter has compound elements composition: Cu - up to 1,15%, Zn - up to 5,9%, Pb - up to 0,65%, Fe - up to 47,0%. Ore granularity is -300 mm. It was planned to install OSC RLP-21T on the heavy belt-type conveyors № 2 and №2A. The list of identified elements is: Cu, Pb, Zn, Ag, Cd, Fe.

At KOF it was planned to install OSC RLP-21T on conveyor №4. Ore granularity -50 mm. The list of identified elements is: Cu, Pb, Zn, Ag, Cd, Fe.

At NPR it was planned to install OCS RLP-21T on the mine's mainstream underground conveyor. Ore granularity -300mm. The list of identified elements is: Cu, Pb, Zn, Ag, Mo, Fe. Ore peculiarities: a) very low content of Ag (on average 2,9 ppm); b) presence of Mo in the ore (on average 110 ppm).

There have been installed more powerful X-ray pipes, silicic drift detectors of large area (download of up to 1GB/s), high speed electronics to provide sustainable work of OCS with the ores which have low content of Ag, Cd and Mo.

There has been preserved the technology of ore sampling tested at ZhOF-1 and ZhOF-2 [1, 2] at OCSs, developed for conveyors of BOF, KOF and NPR. Only at KOF and NPR elements content was issued with 5 minutes intervals.

There was used the «online» control at KOF and NPR installed OCS RLP–21T, which allowed to realize the principle of OCS RLP–21T developer (LLP «Aspap Geo», Almaty). The objects of «online» control are different, ore types are different, industrial ore processing products are different but graduation is the same. At BOF installed OCS RLP-21T we had to reject the unified graduation and switch to by-object graduation.

The results of the accumulated undertaken scientific, methodic and mathematical research based on the newest instrumental base expressed as follows:

4 OSC RLP-21T began operating: 2 are at BOF and 1 is at KOF - «online» ore control for Cu, Pb, Zn, Ag, Cd, Fe and 1 at NPR - «online» ore control for Cu, Pb, Zn, Ag, Mo, Fe.

Very difficult scientific and important industrial challenge was first time solved in Kazakhstan: «online» control over the content of the main (Cu, Pb, Zn) and associated (Ag, Cd, MO) elements with low content of Ag, Cd (1+ppm) and Mo (15+ppm) with ore granularity of –300 mm.

References

1. Yefimenko S.A., Issatayeva F.M., Zhelayeva N.V. Technologies of «on-line» quality control of ores and their processing products at Kazakhmys corporation LLC // Innovative development of resource-saving technologies for mining. Multi-Authored monograph. – Sofia: Publishing House «St. Ivan Rilski», 2018.–P. 245 – 268.

2. Nigmatulin A.M., Abdрахmanova Z.T., Kan A.N., Yefimenko S.A. Nuclear-geophysical technologies of «on-line» control of the chemical composition of copper-containing polymetallic ores // Resource and resource-saving technologies in minerals mining and processing. Multi-authored monograph. – Petrosani. Romania: UNIVERSITAS Publishing. 2018. 162 – 179 s.

UDC 622.7: 622.342 (575.1)

I.K. UMAROVA, Candidate of Technical Sciences, Docent,
S.I. AMINJANOVA, Senior Teacher, Tashkent State Technical
University, Uzbekistan

STUDYING THE MATERIAL COMPOSITION OF THE ORE OF DEPOSIT HANDIZA

A significant increase in the production of metals, complex use of raw materials, involvement in the process of industrial production of new types of ores, reducing the cost of processing, increasing the extraction of metals from ores are the most important and urgent tasks in the development of efficiency and development of mineral resources of Uzbekistan's mineral resources .

The purpose of this work is to study the material composition of ore samples and the development of an effective technology for enriching polymetallic ore from the Chinarsay deposit.

To study the material composition of the ore, medium samples were taken to perform spectral, chemical, rational analyzes, as well as samples and average ore samples with a particle size of 3-0 mm for mineralogical studies and particle size analyzes. The results of the semi-quantitative spectral analysis of the ore sample are shown in Table 1.

Table 1

The results of a semi-quantitative spectral analysis of the sample ore			
Elements	Content,%	Elements	Content,% N
Silicon	>1	Copper	0,3
Aluminum	>1	Lead	>1
Magnesium	0,3	Silver	0,003
Calcium	0,1	Antimony	0,01
Iron	>1	Zinc	>1
Manganese	0,01	Cadmium	0,01
Nickel	0,001	Gallium	0,001
Titanium	0,03	Beryllium	0,001
Vanadium	0,001	Strontium	0,01
Molybdenum	<0,001	Barium	0,03
Zirconium	0,003		

The results of chemical analysis of the average sample are placed in table 2. The specific gravity of the sample is $-2,88 \text{ g / cm}^3$.

Table 2

Results of chemical analysis of an average ore sample			
Components	Content,%	Components	Content,%
Silica	71,8	Lead	2,54
Iron oxide (3+)	3,0	Zinc	5,12
Iron oxide (2+)	1,8	Copper	0,6
Titanium oxide	0,1	Hydrocarbon oxide	-
Manganese oxide	0,01	Ogigr -H ₂ O.	0,8
Alumina	5,2	Sulfur total	6,0
Calcium oxide	0,2	Sulfur oxide (6+)	-
Magnesium Oxide	-	Gold, USD	0,0
Potassium oxide	0,15	15 Silver, USD	40,0
Sodium oxide	0,08		

According to the results of chemical analysis, the content of useful components in the sample: lead -2,54%, zinc -5,12%, copper - 0.6%. The results of the rational analysis of ore are given in table 3. Can be seen from the data in 78,7% of lead, 78,8% of zinc and 98,4% of copper are in sulphide; 14,5% lead, 11.0% zinc are in oxide form. The studied ore sample is characterized by a simple complex of minerals composing them, but they are distinguished by a complex, extremely thin and close mutual germination of minerals among themselves is a great difficulty in their separation. Breed dense small

and medium-grained, light and dark gray color. Plots of rock impregnated with iron hydroxides.

Table 3

Results of a rational analysis of the average ore sample		
Name of compounds	Content, %	Distribution, %
Lead in the form of	total	2,54
	sulphides	1,73
	oxides	0,32
	residue	0,15
Zinc in the form of	total	5,12
	sulphides	4,14
	oxides	0,58
	residue	0,64
Copper	total	0,62
	sulfide	0,61
	bound	0,01

Three minerals grow most closely together - galena, chalcopyrite and sphalerite. Sphalerite ZnS is the most widely distributed mineral in ore. Earlier sphalerite has a dark brown or black color, later sphalerite is light yellow. Dimensions grains vary from hundredths of a mm to 5 mm. In sphalerite there is an emulsion impregnation and thin veins of chalcopyrite. The size of chalcopyrite inclusions is 0,003-0,005 mm.

Galena PbS is the most common mineral after sphalerite in the ore. Galena gives together with chalcopyrite and sphalerite impregnation and veinlets in quartz-sericiterock. The size of monomineral secretions ranges from a few thousandths of a mm to 0,75 mm and less often reaches 1,5-2 mm. Galenite contains inclusions of chalcopyrite, quartz and other minerals. Chalcopyrite $CuFeS_2$ in quantitative terms, the mineral is inferior to sphalerite and galena. Chalcopyrite gives irregular elongated, streaky-like discharge. The grain size of the mineral ranges from a few thousandths of a mm to 2 mm.

The prevailing size is 0,08-0,1mm. The mineral is more often noted in sphalerite in the form of emulsion inclusions.

Chalcopyrite replaces sphalerite and pyrite. The close accretion of chalcopyrite with galena and sphalerite makes it impossible to select pure chalcopyrite.

Ore minerals are in close intergrowth with non-metallic minerals - quartz, sericite, chlorite, carbonate, etc.

Ore is not affected by oxidation processes.

The size of impregnation of useful minerals from emulsion to a few mm, their germination is extremely thin and close, especially close gangling and splenterite, sphalerite and chalcopyrite, galena and chalcopyrite are characterized by close intergrowth.

Pyrite is somewhat detached.

Ore is difficult to grind, and for the disclosure of intergrowth requires fine grinding, it introduces certain difficulties in the preparation of the material before enrichment.

Thus, as a result of the conducted mineralogical analysis, it was established that polymetallic ore is represented by fragments of microquartzite in varying degrees of silicified, sericitized and chloritized.

UDC 622.7: 622.342 (575.1)

S.I. AMINJANOVA, senior teacher,
Tashkent State Technical University, Uzbekistan

STUDYING THE ENRICHMENT OF IRON ORE SAMPLES FROM THE MINGBULAK DEPOSIT

We present the results of studying the material composition of the ore samples from the Mingbulak deposit. his paper presents the results of enrichment of the specified sample of ore. Ore was enriched by methods of gravity, dry and wet magnetic separation. Table 1 shows the results of gravitational enrichment of ore at different grind sizes.

Table 1

The results of experiments gravitational enrichment of the sample ore

Products enrichment Iron	Выход, % Yield,%	Iron Content,%	Extraction,%	Coarseness grinding, mm
Gravioconcentrate	52,32	59,0	64,31	-1+0
Promprodukt	18,5	39,9	15,38	
Tails	29,18	33,41	20,31	
Ore	100	48,0	100	
Gravioconcentrate	58,2	60,0	72,45	-0,5+0
Promprodukt	21,0	39,2	17,07	
Tails	20,8	24,27	10,48	

Ore	100	48,2	100	
Gravioconcentrate	57,32	66,0	78,32	
Promprodukt	24,41	29,4	14,86	
Tails	18,27	18,02	6,82	-0,315+0
Ore	100	48,3	100	
Gravioconcentrate	55,72	67,0	77,45	
Promprodukt	23,77	29,4	14,5	
Tails	20,51	18,92	8,05	-0,15+0
Ore	100	48,2	100	

As can be seen from the data presented in Table 1, the best results were obtained with the gravitational enrichment of size classes - 0,315÷+0 and -0,15÷+0 mm.

Gravity concentrates containing 66-67% of iron were obtained, while extracting it, 78,32-77,45%. Gravitational scheme of enrichment of iron-containing samples of ore from mingbulak deposit

Experiments were conducted on dry and wet magnetic separation of samples (Fig. 2).

For dry magnetic separation, the current strength was 0,25 A, for wet magnetic separation - 3 A.

The results of experiments on magnetic separation of ore are shown in Table 2.

Table 2

The results of magnetic separation of ore

Products enrichment	Products Yield,%	Iron content,%	Iron extraction,%	Size class, mm
Dry magnetic separation				
Magnetic fraction	95,5	50,0	99,48	-2+0
Nonmagnetic fraction	4,5	5,56	0,52	
Ore	100	48,0	100	
Magnetic fraction	95,5	49,6	99,1	-1+0
Nonmagnetic fraction	4,5	9,5	0,9	
Ore	100	47,8	100	
Magnetic fraction	96,0	49,64	99,28	-0,5+0
Nonmagnetic fraction	4,0	8,6	0,72	
Ore	100	48,0	100	
Magnetic fraction	96,0	49,89	99,15	-0,315+0
Nonmagnetic fraction	4,0	8,0	0,85	
Ore	100	47,8	100	
Magnetic fraction	98,0	48,79	99,6	-0,15+0
Nonmagnetic fraction	2,0	9,5	0,4	
Ore	100	48,0	100	

Based on the studies performed, the processing of ore from the Mingbulak deposit is proposed for wet magnetic separation with the release of iron concentrate.

According to the recommended scheme, a magnetic fraction containing 63% of iron was obtained when extracting it was 92,62%.

G.K. SALIJANOVA, Docent, Tashkent State Technical University, Uzbekistan

THE RESULTS OF ENRICHMENT OF SAMPLES OF ORE DEPOSITS SARYCHEKU USING TRADITIONAL AND LOCAL REAGENT "PS"

In the Republic of Uzbekistan, at the beneficiation plants, for the enrichment of various ores, traditional reagents manufactured abroad are used. At present, it has become necessary to test local reagents and introduce them into the industry. Replacing traditional reagents with new ones - import-substituting reagents is relevant. Creating reagents made from local raw materials will replace the scarce traditional reagents and save a significant amount of currency.

At present, there are four enterprises in the republic in which copper - molybdenum ores are being floated - the OIP, the SOF and gold-bearing ores - the AZDR, and also the GMZ - 3 GP NGMK. In these enterprises, BPC is used as the main reagent - collector, T-80 (oxal) as a frother, or T-92. In this paper, we present the results of the enrichment of copper ore samples from Kalmakyr and Sarychek deposits with traditional reagents and local reagents. Samples of ore prepared by the standard method.

In order to study the material composition of ore samples, ore samples were taken for mineralogical analysis, medium samples were prepared for performing spectral, chemical, particle size analyzes.

Chemical analysis in a sample of ore from Sarychek deposit is determined in (%): SiO_2 - 56,3; Fe_{obsh} - 2,66; Fe_2O_3 - 1,52; FeO - 1,98; TiO_2 - 0,43; MnO - 0,09; Al_2O_3 - 12,2; CaO - 2,24; MgO - 15,4; K_2O - 5,84; Na_2O - 0,92; $\text{S}_{\text{обш}}$ - 1,58; $\text{S}_{\text{sulfate}}$ - 1,53; SO_3 - 0,12; CO_2 - 0,88; P_2O_5 - 0,13; Cu - 0,36; Pb - 0,004; Zn - 0,008; As - 0,01; Mo - 0,002; Au - 0,2 y.e.; Ag - 4,7y.e. ип.п.п. - 2,46. Semi-quantitative spectral analysis in the middle ore sample was determined (at %): Ni - 0,002; V - 0,004; Cr - 0,003; Zr - 0,004; Ga - 0,001; Be < 0,06; Sr - 0,01; Be < 0,001; I - 0,001.

Copper minerals were floated with a mixture of potassium butyl xanthate (BPC) and potassium isopropyl xanthate (IPPC) in a 1:1 ratio. Using local reagent "PS" conducted flotation experiments in

open and closed cycles. At the same time, the consumption of a mixture of xanthates is reduced by 50% when adding reagent "PS" - 150 g/t, the consumption of the remaining reagents is not changed.

During flotation of copper ore samples from the Sarychek deposit, the following optimal flotation mode was determined using traditional reagents:

grinding size % class. - 0,074 mm - 65; reagent consumption g/t: in the grinding of lime (by CaO) - 400;

to the main flotation of Na₂S -40; BKK + IPKK - 15; T- 80-20; to control flotation Na₂S - 8; BKK + IPKK - 7,5; T-80-10;

regrinding of rough concentrate % class - 0,074 mm - 98,0; flotation time, min: primary - 10; control - 7;

1 cleaning - 5, 2 cleaning - 4.

When using local reagent "PS" the consumption of reagents of collectors was, g/t; in the main "PS" -100; BKK + IPKK - 7.5;

in the control BKK + IPKK - 3,5; the rest unchanged.

Table 1

The results of the flotation of the sample ore deposits Sarycheku using traditional reagents in the optimal mode

Products	Yield,%	Content%		Recovery,%	
		copper	sulfur	copper	sulfur
Open loop					
Concentrate	1,8	17,56	15,02	83,2	16,9
Promprodukt 1	5,7	0,19	1,18	2,9	4,2
Promprodukt 2	3,2	0,51	1,9	4,3	3,8
Promprodukt3	6,8	0,16	6,87	2,8	29,2
Tails	82,5	0,031	0,89	6,8	45,9
Ore	100	0,38	1,6	100,0	100
Closed loop (on a continuous process basis)					
Concentrate	2,1	15,29	15,12	89,2	20,1
Tails	97,9	0,039	1,29	10,8	79,9
Ore	100	0,36	1,58	100	100

Table 2

The results of the flotation of ore deposits Sarycheku using local reagent "PS" and 50% consumption of a mixture of xanthates

Products	Yield,%	Content%		Recovery,%	
		copper	sulfur	copper	sulfur
Open loop					
Concentrate	1,2	24,15	22,88	82,8	17,6
Promprodukt 1	4,6	0,23	1,19	3,0	3,5
Promprodukt 2	4,3	0,37	1,34	4,5	3,7
Promprodukt3	5,9	0,18	6,93	3,0	26,2
Tails	84,0	0,027	0,91	6,7	49,0
Ore	100,0	0,35	1,56	100,0	100,0
Closed loop (on a continuous process basis)					
Concentrate	1,5	21,6	24,65	90,0	23,4
Tails	98,5	0,036	1,23	10,0	76,6
Ore	100,0	0,36	1,58	100,0	100,0

Comparing the results of the experiments are given in table.

land 2, we can assume that the indicators for copper extraction are almost the same, but the quality of the concentrate is higher in experiments using "PS".

As a result of the conducted studies, recommended schemes for flotation of ore samples from the Sarychek deposit using a combination of traditional collectors and "PS" while saving BKK + IPKK at the level of 50% were developed and flotation concentrates of higher quality were obtained.

UDC 65.011.56: 622.7.05

M.R. SHAUTENOV, Professor,

G.E. ASKAROVA teacher,

M.E. NURDAN, student, Satbayev University, Kazakhstan

ANALYSIS OF GRAVITY-FLOTATION ENRICHMENT OF REFRACTORY GOLD ORES COMBINED WITH METALLURGICAL PROCESSES

Kazakhstan is one of the leading regions in the extraction of precious metals. However, the growth of production is accompanied by a gradual depletion of reserves of rich and easily rich ores, which requires the involvement in the processing of complex composition, persistent ores of poor quality. Currently, geological exploration is aimed at further exploration, additional exploration and re-evaluation of reserves and resources at prospective sites of persistent gold ores, which include a significant amount of arsenic and natural carbonaceous matter.

Technologies based on the use of combined schemes combining gravity-flotation enrichment with various methods of metallurgical processing of refractory concentrates are proposed for the processing of refractory sulfide gold-arsenic ores.

To extract gold from refractory ores containing carbonaceous matter, various methods are used to neutralize its sorption activity. During sorption leaching of carbonaceous ores, the process parameters significantly depend on the ratio between the gold and silver content in the ore.

Technologies based on the use of combined schemes combining gravitational and flotation enrichment with the production of sulfide gold - containing concentrates pyro-or hydrometallurgical processes for gold extraction are proposed for the processing of refractory gold ores. Such concentrates are characterized by fine impregnation of gold in pyrite and arsenopyrite, also belong to the category of persistent, and the extraction of gold by cyanidation can be carried out only after the destruction and oxidation of sulfide carrier minerals.

Gold-containing sulfides (pyrite, arsenopyrite, chalcopyrite) in their natural state have relatively high flotation activity. It is established that the flotation of the primary ore is preferably carried

out in a neutral environment. Gold recovery to the flotation concentrate from partially oxidized ore was 57,47 %.

The result of the mineralogical analysis of flotation tailings indicated the presence in their composition of complex aggregates (arsenopyrite with quartz, limonite, chalcopyrite and sphalerite, with Galena in cerussite "shirt"), not disclosed in this fineness of grinding; the presence of crusts of scorodite on the surface of arsenopyrite, raids and coatings of iron hydroxides on the surface of the gold particles. Therefore, in order to increase the recovery and reduce the loss of gold with tails, it becomes obvious that there is a need for additional cyanidation of flotation tails after their grinding.

References

1. Bogdanov O.S., Maksimov I.I., Podnek A.K., Yanis N.A. Theory and technology of flotation of ores, Moscow, Nedra, 1990, p. 363. (in Russian).
2. Abramov A.A. Technology of processing and enrichment of ores of non-ferrous metals, Moscow, Publishing house. MGGU, 2005, p. 470. (in Russian).

UDC 66.061.34: 579.66

V.Yu. CHERNENKO, Candidate of Medical Sciences (Genetics),
Associate Professor,

I.M. ASTRELIN, Doctor of Technical Sciences, Professor, Dean of
the Faculty of Chemical Technology,

N.M. TOLSTOPALOVA, Candidate of Technical Sciences,
Associate Professor, Acting Head Department of technology of
inorganic substances, water treatment and general chemical
technology,

National Technical University "Igor Sikorsky Kyiv Polytechnic
Institute", Kyiv, Ukraine

ENRICHMENT AND LEACHING OF NON-FERROUS METAL ORES AND PHOSPHATE ORES WITH ORGANIC ACIDS

Modern biohydrometallurgy involves the use of leaching agents both at the stage of ore dressing and at the stages of its subsequent processing [1]. Ecologically safe and non-toxic organic acids are suggested to be used as highly active leaching agents. The latter are

produced on an industrial scale from vegetable raw materials using microbial synthesis technology. According to our calculations, using organic acids, it is possible to process up to 1 million tons of ore per season at one mining and processing plant. The authors of this work carried out theoretical calculations and laboratory experiments on industrial processing of carbonate-bearing rocks in order to enrich these ores and increase the efficiency of extraction of non-ferrous metals and related chemical elements. The idea is completely new, unconventional for non-ferrous metallurgy, but tested in laboratory conditions on various types of mineral raw materials obtained from domestic and foreign mining and processing plants of metallurgical and phosphate-producing profiles. In the laboratory of biohydrometallurgy and biotechnology NTU "Igor Sikorsky KPI" studied a sufficiently large number of mineral types for the possibility of leaching various chemical elements with organic acids.

Among the studied minerals only aluminosilicates-biotite $K(Mg, Fe)_3(AlSi_3O_{10})(OH)_2$,

garnierite $(Ni, Mg)_4Si_6O_{15}(OH)_2 \cdot 6H_2O$,

imite $(Ni, Mg, Fe, Al)_6(AlSi_3)O_{10} \cdot (OH)_8$ and glauconite

$(K, Na)(Al, Fe^{3+}, Mg)_2 \cdot (Al, Si)_4O_{10}(OH)_2$ have particularly

resistant to acid leaching of the crystal lattice. However, these minerals are effectively leached with such "soft" organic acids as citric and oxalic, but at melting points (153 and 190 °C, respectively), i.e. in the melt of these acids. In such conditions, the leaching reactions proceed very rapidly and the target element (for example, nickel) can be reduced electrolytically directly from the melt, at the same (153 and 190 °C) temperatures. And if these temperatures are significantly lower than traditional pyrometallurgical (for example, 153 °C compared to the melting point of nickel of 1453 °C), then it is logical to suggest the introduction of such technology in the production of non-ferrous metals. Such a technological technique can provide a significant economic effect.

As for carbonate minerals - azurite, malachite, calcite, magnesite, dolomite, siderite, rhodochrosite, these minerals in comparison with aluminosilicates, under the action of the above listed organic acids, are very easily leached. Under certain conditions, pre-crushing of the ore

(to the size of -0,071 mm), heating the ore mass together with the leachant to the melting point of organic acid, active mixing (including cavitation vibration), the leaching process of the target metals is completed in a few minutes (25-35 minutes). Data on the kinetics of carbonate leaching processes with organic acids are given in our previous work [1]. For example, when leaching azurite or malachite with lactic acid, a water-soluble salt is formed copper lactate

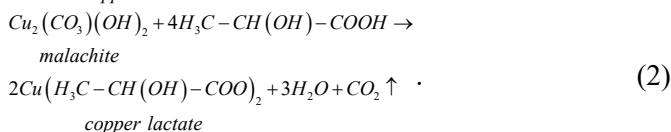
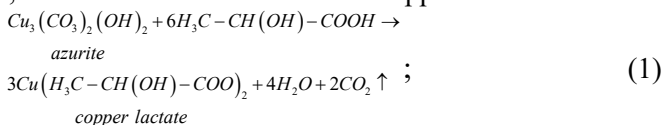

From the copper lactate obtained in this way, metallic powder copper can be obtained by a redox reaction with hydrazine hydrate

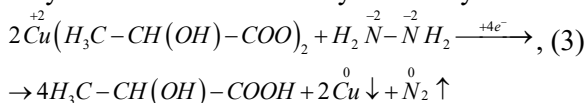

in ionic form, this reaction has the form:

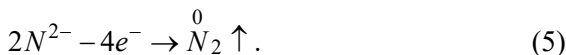
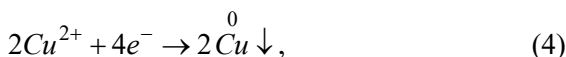

One of the strongest organic acids is oxalic. The ionization constant of oxalic acid in aqueous solution ($K_{i\text{C}_2\text{H}_2\text{O}_4} = 5,6 \cdot 10^{-2}$) (indicator of ionic acid strength) is 7 times higher than the same indicator of phosphoric acid ($K_{i\text{H}_3\text{PO}_4} = 8 \cdot 10^{-3}$) and indicates the ability of oxalic acid to leach phosphates in the form of phosphoric acid from apatites:

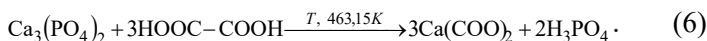

Similar reactions occur when using citric acid, but under the conditions of the latter melt (), i.e. in non-aqueous environment:

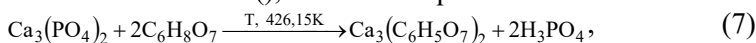

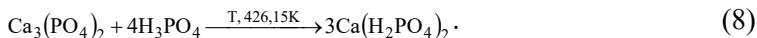

The listed examples of extraction of non-ferrous metals and phosphates demonstrate the possibility of practical application of a new bio-hydrometallurgical approach to the technology of enrichment and leaching of polymetallic ores and phosphates using organic acids.

References

1. Chernenko V.Yu. Thermodynamic basis of environmentally-friendly technology of dissolution of carbonic polyminerals by biogenic agents / V.Yu. Chernenko, I.M. Astrelin I.M. // Research bulletin of the National Technical University of Ukraine "Kyiv Polytechnic Institute". – 2010. – №5 (73). – P. 145 – 152.

UDC 67.03

O.M. KORCHUGANOVA, PhD (Engineering), Associate Professor,
O.V. LYUBIMOVA-ZINCHENKO, PhD (Engineering), Associate Professor,

R.G. ZAIKA, PhD (Engineering), Associate Professor,
 V Dahl East Ukrainian National University, Ukraine

THE ENREACHING OF CLAY AS RAW MINERAL FOR PIGMENTS

Thanks to the resistance of mineral pigments to the influence of light and chemicals, as well as cheapness, the protection is widely used for all types of paints: glue, oil, etc.

The corrosion resistances of paints that are pigmented with ocher are better than when synthetic mineral pigments are used. This is due to the exclusive corrosion resistance of the pigment. The property to resist the process of oxidation of metals in combination with other components of paint and varnish coating is intensified. The inhibitory effect of these pigments slows or completely blocks the corrosion process even when water penetrates through a paint film, since they create anodic iron protection.

The intensity of the coloration of ocher depends on the content of chromophore oxide. By content of iron, oxide ocher is divided into ordinary (iron oxide content, converted to Fe_2O_3) is 12-20% and iron oxide containing - iron oxide up to 70-75%.

However, the requirements for the standard are set for pigments intended for industrial use. The main indicators of pigment quality are:

The iron content, in terms of Fe_2O_3 , is 9%
 Oil content – 40 g/100 g of pigment.
 Coverage – 65 g/m^2 .

Natural deposits are not too homogeneous, and in certain locations quality indicators may differ from the standards.

Such ochers need to be enriched. It is possible to offer both physical and chemical methods for enriching ocher by iron oxide.

The series of experiments on classification and enrichment of the ocher of the Markovka deposit (Lugansk region) has been conducted. The chemical composition of the initial clay is presented in Table 1.

The clay was crushed, classified by means of a two-stage vortex dust collector [1], the separation of particles of clay powder was based on the action of centrifugal forces. The dust collector divided the clay into two main parts: 1) the fines - the residue on the sieve of 0,1-5,29% and 2) the large - the residue on the sieve of 0,1-81,7%.

Table 1
 The chemical composition of the initial clay

Component	SiO_2	Al_2O_3	Fe_2O_3	TiO_2	CaO	MgO	P_2O_5	K_2O	Na_2O	SO_3	Spent under calcinat ion
from	59,34	7,31	7,50	0,43	5,73	0,38	0,00	0,82	0,10	Res.	3,7
to	81,90	13,98	22,4	0,85	17,1	1,24	0,05	1,8	0,37	0,5	6,3

After separation, individual fractions were analyzed on iron content. The results are as follows: the fine fraction contained 4.49% wt. iron, large fraction - 7.00% wt. iron.

Consequently, it is quite obvious, and it was previously established by other researchers - larger fractions contain more iron at the expense of limonite.

But at the same time, limonite is a more solid component of ocher and is worse crush. Therefore, the fine fraction, which is more suitable on granulometric composition for the manufacture of pigment as a result of classification, is impoverished and requires enrichment.

Subsequently, a fine fraction was added synthetic iron oxide pigment [2]. The qualitative characteristics of the pigment obtained from enriched clay are as follows:

The iron content, in terms of Fe_2O_3 , is 20%

Oil content - 42 g/100 g of pigment

Coverage - 62 g/m².

Therefore, the clay of the Markov deposit can be brought to a conditional state by enrichment. It is proposed to use both physical (grinding and classification) and enrichment by introducing synthetic iron oxide pigment.

References

1. Patent of Ukraine № 2000074123 B01D46/00, 46/24 Vortex dust collector // Appl. 12.07.2000, publish. 15.10.2002 bul. № 10.
2. Patent of Ukraine № 108772 C09C 1/22 C01G 49/00 The method of ironoxide pigment producing// Appl. 21.06.13, publish. 10.06.15 bul. №11.

Section “Mining Machines and Equipment”

UDC 622.692.4:628.1.648.693.192

L.I. MAKHARADZE, Doctor of Technical Sciences, Professor, LEPL
G. TSULUKIDZE Mining Institute, Georgia

METHODS AND MEANS OF ENSURING SAFE AND RELIABLE OPERATION OF PRESSURE PIPELINES OF HYDROTRANSPORT SYSTEMS

Pressure pipeline hydrotransport is currently widely used in many sectors of industry, agriculture and household services (water supply pipelines, pipeline hydrotransport of various solid loose abrasive materials, oil pipelines, oil product pipelines, irrigative pipeline systems).

Relative disadvantage of these systems is the circumstance that during their operation hydraulic shock often occur for various reasons when there is almost instant increase of pressure in pipelines whose value significantly exceeds their value in a steady mode.

Probability of occurrence of non-steady processes and hydraulic shock in multi-step systems when centrifugal pumps are sequentially connected to the main pipeline system and when in the places of their connection to the main pipeline system the interruption of the flow of the liquid medium transported through the pipeline does not occur is rather high.

In such systems even in cases considered by the operation technology (in case of starting and stoppage of sequentially connected pipes), hydraulic shocks may occur in case of non-compliance with the necessary sequence of start and stoppage of sequentially connected pumps and observation of intervals between these operations as established by us.

As a rule, such conditions lead to serious accidents and destructions with a high economic loss.

All this is felt particularly acutely if solid loose materials of high abrasiveness are transported by pressure pipelines. In analogous

systems, due to presence of solid loose materials of high abrasiveness in the main pipeline system, non-steady processes apart from the above cases may occur: in case of change of granulometric composition of solids, due to partial or full siltation of pipeline, due to quick plugging of the main pipeline system. In these systems, depending on mechanical characteristics and parameters of solids, hydroabrasive wear of pipeline walls occurs which must be also considered.

For the purpose of prevention of creation and development of hydraulic shocks, measures must be taken which can prevent their creation and ensure safe and reliable operation of pressure pipelines of hydrotransport systems.

Considering the scale and significance of the problem, fundamental researches of the reviewed problem were performed G.

Tsulukidze Mining Institute during half a century. Effective methods and means were developed which will ensure safe and reliable operation of pressure pipelines of hydrotransport systems.

Their novelty and usefulness are protected by patents and copyright certificates, their effectiveness and reliability are established on large industrial systems.

The theory and algorithms of calculation of their structural elements and performance parameters have been developed. The normative guideline document for protection of pressure hydrotransport systems from hydraulic shocks has been developed.

Reference

1. **Makharadze L.** Protection of hydrotransport systems from water hammers, Tbilisi: Metsniereba, 1996, 150 p. (in Russian).
2. **Makharadze L.** Guiding principle for protection of hydrotransport systems from water hammers BCH 01-1981, Tbilisi: Metsniereba, 1981, 151 p. (in Russian).

UDC 622.74: 621.928.235

V. YATSUN, PhD (Engineering), Associate Professor, Central Ukrainian National Technical University, Ukraine

EXPERIMENTAL RESEARCH OF RECTILINEAR TRANSLATIONAL VIBRATIONS OF A VIBRATOR PLATFORM BY A BALL AUTOBALANCER

Designs of the new vibratory machines have been proposed and the operational performance of several such machines has been studied theoretically, employing 3D modeling, and conducting the field and computational experiments.

It is a relevant task to experimentally investigate the workability of the specified excitation method for dual-frequency resonance vibrations for a single-mass vibratory machine with the rotational-oscillatory motion of platform.

Paper [1] suggested using, as a dual-frequency vibration exciter, a passive auto-balancer of the ball-, roller-, or pendulum- type. Under certain conditions, correcting loads get together, cannot catch up with the shaft onto which the auto-balancer is mounted, and get stuck at the resonance frequency of platform oscillations. This is how the first, inertial vibration, exciter forms, stimulating slow resonant oscillations of the platform. The unbalanced mass is installed on the casing of an auto-balancer. This is how the second, inertial above-resonance vibration, exciter forms, exciting fast (above-resonance) oscillations of the platform. Dual-frequency vibration parameters are changed by altering the speed of shaft rotation, the unbalanced mass on the auto-balancer's casing, the total mass of loads.

The workability of the new method was investigated for a single-mass vibratory machine with a rectilinear translational motion of platform, applying 3D modeling, by conducting a field experiment, analytically, and in the course of computational experiments.

Of relevance is the initiation of dual-frequency vibrations in single-mass vibratory machines with the rotational-oscillatory motion of platform [2]. Such machines have a simple structure and a single resonance frequency, facilitating the task of their design.

Given the above, it is relevant initially to experimentally explore the law of rotational-oscillatory vibrations of a vibratory machine platform, excited by the ball auto-balancer.

Researches were conducted within the state budgetary subject financed by the Ministry of Education and Science of Ukraine.

References

1. Filimonikhin, G. Method of excitation of dual frequency vibrations by passive autobalancers/ G. Filimonikhin, V. Yatsun // Eastern-European Journal Of Enterprise Technologies. – 2015. – Vol. 4, N 7(76). – P. 9–14. doi: 10.15587/1729-4061.2015.47116.

2. Yatsun, V. Experimental study into rotational-oscillatory vibrations of a vibration machine platform excited by the ball auto-balancer / V. Yatsun, G. Filimonikhin, A. Nevdakha, V. Pirogov // Eastern-European Journal Of Enterprise Technologies. – 2018. – Vol. 4, N 7(94). – P. 34–42. doi: 10.15587/1729-4061.2018.140006.

UDC 629.114:622.684

Ju.A. MONASTYRSKIY, Doctor of Engineering Science,
Professor,

V.V. POTAPENKO, Senior lecturer,
Kryvyi Rih National University, Ukraine

I.V. BONDAR, TOV Servisnyj tovgovo-logistichnij centr BELAZ
UKRAINA

ADAPTIVE SYSTEM OF TECHNICAL OPERATION OF OPEN PIT TRUCKS

Positions of open-pit mining become stronger, the ratio of technological motor transport, which is component of transport and technological complex of open pits, increases. At the production plants of Ukraine there are used two thousand open pit trucks of BELAZ-HOLDING production, over 300 BELAZ open pit trucks work in the Kryvyi Rih basin, and more than a half of them – the BELAZ-75131 with a loading capacity of 110-136 t. For the last three years the equipment fleet increased by more than 80 units.

Deepening of workings worsens mining conditions, raises operational loadings, reduces reliability of the equipment and efficiency of transportation. Reliability of the system of

technological motor transport (STMT) of an open pit is key indicator as for cost-effective control of open pit trucks operation, and for all pit in general.

Long and reliable work of open pit trucks is possible on condition of systematic and high-quality technical servicing and repair (TSR) therefore justification of parameters of functioning of technological motor transport of deep open pits, which will allow to lower costs of technical operation of open pit trucks, is relevant scientific task.

The purpose of the real researches is increase in efficiency of operation of technological motor transport of deep open pits by use of reasonable parameters of technical servicing and repair.

The problem of improvement of the TSR system belongs to planning and development of methods of control of technical servicing and repair of the rolling stock, optimization by criterion of minimization of the given costs of service "transportation of mined rock".

Object of researches are processes of technical operation of industrial technological motor transport of deep open pits, and the subject – interrelation of parameters of technical servicing and repair and technical and economic indicators of technological motor transport of deep open pits.

As a result of researches for the first time there was developed complex mathematical model of the BELAZ open pit trucks operation, which on the basis of the TSR operating structure unites models of resource and technological states, flow of events, spaces of influences, transitions.

The model allows to define the place and condition of cars in processes of work and technical operation, to determine probabilities of their states in the dynamic and set modes for various levels of the TSR organization.

There was synthesized mathematical model of adaptive steering of the system of technological motor transport of deep open pit on the basis of economic criterion as extreme task with the restrictions connected with technological conditions of STMT.

Optimum control actions are calculated in the form of intensity of planned impacts of TSR on open pit trucks and intensity of transitions from conditions of planned technical servicing, repairs and maintenance of the car to condition of work.

The technical and economic model of optimization of systems of technological motor transport of deep open pits is improved due to addition of the third dimension in the form of shaft of probability of work condition which has united readiness of cars, the TSR complex parameter and labor input that has allowed to receive the surface of influence and trajectory of optimum technical operation of open pit trucks and STMT in general.

The algorithm and technique of dynamic correcting of adaptive system of technical operation of BELAZ open pit trucks at the expense of the synthesized control, which allows to configure reasonably settings of technical servicing and repair of technological motor transport of deep open pits, adapting for the concrete enterprise for criterion of minimum of labor input of technical operation, have gained further development.

UDC 629.114

KOUROUMA IBRAHIMA KALIL , enseignant de
ISMGB, Boké, Rép. de Guinée;

POZDNIAKOV VALERII, docteur es sciences, maître de
conférences, UGANC, Conakry, Rép. de Guinée ;

BAH BRAHIMA, docteur es sciences, maître de conférences,
UGANC, Conakry, Rép. de Guinée

AMELIORATION EN QUALITE DE LA PRODUCTION BAUXITIQUE DES GISEMENTS DE LA COMPAGNIE DES BAUXITES DE GUINEE (CBG), REPUBLIQUE DE GUINEE

La nature a doté le sous-sol guinéen d'immenses ressources minières jusqu'à présent exploitées en partie. Parmi ces ressources on peut citer: la bauxite, le fer, l'or, le diamant et d'autres. La bauxite occupe une place de choix à cause de ses immenses réserves exploitables suivant les normes technologiques actuelles. Il est établie qu'elle détiendrait près de deux tiers (2/3) des réserves mondiales prospectées.

Depuis quelques années, la CBG (Compagnie de Bauxites de Guinée) est baignée dans un environnement technologique profondément concurrentiel. Face aux exigences de réduction des coûts de l'aluminium et des délais, et à celles d'amélioration de la qualité, les responsables de la compagnie continuent à mettre en oeuvre des moyens plus perfectionnés sans cesse pour satisfaire de façon efficiente leurs partenaires.

La planification de la production, la gestion des stocks de bauxites, l'organisation en juste à temps (JAT), les stratégies logistiques constituent les principaux leviers sur lesquels l'entreprise doit agir pour atteindre ses objectifs de qualité.

Privilégiant toujours la clarté d'exposition et la réflexion. On propose d'analyser chaque secteur de production selon plusieurs angles d'attaque.

Pour une question de compréhension des anomalies de qualité liées à la production bauxitique, on a utilisé le brainstorming (Débat participatif) pour répertorier les problèmes récurrents des différentes opérations à savoir: le décapage, le forage, échantillonnage, minage, chargement, stockage et expédition.

A travers d'autres outils de contrôle qualité (les diagrammes d'Ishikawa et de Pareto), on a réussi à mettre en relation les causes de ces problèmes et leurs effets.

Le diagramme de Pareto a été utilisé pour identifier les causes essentielles de la non qualité des différentes opérations de production, afin de s'attaquer prioritairement à ses causes, plutôt que de dissiper les efforts dans toutes les directions à la fois.

L'étude de la problématique du maintien de la qualité de la bauxite à la mine de Sangarédi, selon les outils statistiques de suivi utilisés, il ressort que les paramètres de qualité étudiés ne sont pas maîtrisés (particulièrement la silice).

Sur l'ensemble des dix-huit bateaux pris comme échantillon, quatorze ne répondent pas aux normes de spécification de la silice ($\text{SiO}_2 = 1,8 \pm 0,3\%$). L'origine de la non-conformité de la silice a été rattachée à son caractère de non corrélation avec les autres paramètres de qualité.

Il est aussi important de souligner que les causes les plus profondes de non-conformité résident dans les sections de forage,

aménagement des chantiers d'extraction et la reprise de la bauxite au stock.

Les méthodes utilisées, même si certaines peuvent apparaître plus proches de la statistique que de la qualité, sont très fréquemment utilisées dans la plupart des entreprises industrielles mettant en oeuvre un contrôle de qualité.

Le diagramme de contrôle ou carte de contrôle permet de suivre l'évolution de la production souvent au fil des jours, permettant aux responsables ou aux opérateurs d'engager les actions correctives dès qu'elles sont nécessaires.

UDK 622.684

V.I. PAKHOMOV, candidate in technical sciences,
M. G. PRISTINSKIY senior teacher,
S. M. PRISTINSKIY, asistent,
Krivyi Rih national university

THE WAY OF THE COMPLETE UTILIZATION OF A SERVICE LIFE OF THE LARGE-DIMENSION TIRES OF CAREER DUMP TRUCKS

By a basic form of technological transport with the extraction of the minerals in an open manner is truck transport. In the prime cost of the transportation of the rock mass 50-60% of the expenditures comprise the expenditures for motor transport, from which the expenditures for tires comprise 25-30%.

The development of career truck transport assumes an increase in its load capacity, respectively increase in the load on the tires, which leads to reduction in their resource the analysis of the operation of career dump trucks at the enterprises of Krivoy Rog pond shows for the insufficient utilization of the service life of large-dimension tires, this became the vital problem, after solving which it is possible to attain reduction in the expenditures for tires, to increase the coefficient of technical thus will lower the prime cost of the transportation of rock mass.

The basic reasons for the insufficient utilization of the service life of large-dimension tires are: the natural wear of protector; thermal and fatigue failures – the scaling of protector, sidewalls, the stratification of cord and the rest; the mechanical damages, caused by cuts, by punctures and by chippings of cleats and the rest; the plant damage, caused by the defects, which were not discovered with the output control at the plant producer.

Of all reasons for the insufficient utilization of large-dimension tires enumerated above controlled is thermal and fatigue failures.

Thermal and fatigue failures occurs because of overheating of tires.

At temperatures more than 110-120°C, which is considered critical, occurs worsening in the mechanical properties of the material of tire, because of what occurs reduction in the reliability, i.e., wear resistance and strength decreases. Therefore with the operation of large-dimension tires it is necessary to observe their optimum temperature range.

Directly to the thermal condition of tires renders many operational factors, basic from which they be: the clearing ratio of load capacity; the average service speed of motion; the front rake of road; the temperature of ambient air.

To influence and to govern the data by factors is not always possible, but some not at all yield to control, since. a change in the longitudinal section of road, possibly, only in the stage of the formation of quarry, and to the temperature of ambient air generally it cannot be in any way influenced.

There remains only two factors, with the aid of which it is possible to influence the service life of the large-dimension tires: the clearing ratio of load capacity and the average service speed of the motion of career dump truck.

During control of these factors dive the possibility to explore tires in the optimum temperature range prolong their period of service and as consequence, to a reduction in the prime cost of the extraction of minerals.

References

1. Control of the service life of tires as the factor of an increase in the effectiveness in the work of career dump trucks. / Khoreshok A.A., Kulpin A.G., Kulpina E.E. //mining equipment and electromechanics - 2009 - №5 – Of p.45-47.
2. Control of the indices of the operating conditions of large-dimension tires and their influence on the productivity of career dump trucks. / Kulpin A.G., Stenin D.V., Kulpina E.E. //the collector of the materials XV of international practical-scientific conference “the natural and intellectual resources of Siberia. SIBRESURS 2014».
3. Career motor transport: state and prospect. / Mariev P.L., Kuleshov A.A., Yegorov A.N., Zyryanov I.V. - St. Petersburg: Science, 2004. – p.429.
4. Procedure of the determination of the effect of operating conditions on the longevity of the construction of career dump trucks. / Zyryanov N.V. //nonferrous metallurgy. – 1994. –№ 4-5. - p.22-23.
5. Operation of career dump trucks with the electromechanical transmission. / Kazarez A.I., Kuleshov A.A. /M.: Nedra, 1988. - p.264.

UDK 621. 5

I. M. CHEBERYACHKO, Cand. Sc. (Tech.), Associate Professor,
O. P. TROFYMOVA, Assistant Lecturer, National Technical
University «Dnipro Polytechnic», Ukraine

FACTORS EFFECTING THE EFFICIENCY OF THE COMPRESSOR PLANT OPERATION

Pneumatic power is the basic type of energy to mechanize and automate main and auxiliary processes in terms of numerous ore-mining enterprises. Nowadays, general-purpose reciprocating and turbine-type compressors are applied to provide mines and open pits with compressed air.

To improve service life and reliability of the operation of technological equipment of pneumatic plants, inlet atmospheric air should be purified in special-purpose efficient filters which are mounted in special chambers.

Atmospheric air at ore-mining enterprises always contains mechanical impurities (fine particles of ore, coal). Having entered the compressor, the dust contaminates air channels and valves accelerating wearing of working surfaces of impeller wheels and

cylinders as well as compressor seals; that effects the reliability and operating mode of the compressor.

As a rule, water used in cooling systems contains great amount of impurities represented by numerous amount of such components as sand, algae, and mineral salts.

Under the effect of high temperatures, those impurities form dense thermal scale crust on heat-transferring surfaces with the following deterioration of a heat transfer process between the heated air and cooling water. The latter results in insufficient cooling of compressed air which enters next section of increased pressure as well as in deterioration of economic indices of the compressor plants operation.

To reduce harmful effect of that factor, heat-transferring surfaces of intermediate air-cooling units are purified periodically at compressor stations to clean the equipment of contaminations and scale deposits. Reduced time of the workover intervals of the compressor operation allows operating it in rather economy mode; however, in this context, maintenance costs to clean heat-transferring surfaces of air-cooling units increase.

Excessive electric power consumption for the period of continuous compressor operation consists of excessive electric power consumption due to the increase in power consumed by a drive of the baseline compressor and electric power consumptions by a standby compressor compensating decreases in the supply by the baseline one.

Taking into consideration the amount of compressor operation cycles over a one-year period (in terms of preset period of maintenance operations and average daily electric power charge tariff), it is possible to calculate the costs for additional electric power during a year. In terms of the known cost of one repair to clean heat-transferring surfaces, one can calculate the maintenance costs over a one-year period.

Total losses due to additional costs for electric power and maintenance operations over a one-year period will consist of the costs for additional electric power during a year and costs for maintenance operations over a one-year period.

Maintenance operations to clean heat-transferring surfaces include costs for materials (chlorhydric acid, gasket material of paronite, gland packing, water for etching washing solution, and air testing), costs for salaries connected with the cleaning of intermediate air-cooling units taking into consideration salary and duration of maintenance operations as well as monthly gross payroll for the staff.

Thus, function of total costs connected with the compensation of the decrease in compressor supply at the expense of the standby compressors operation and costs for maintenance operations has the minimum in terms of certain value of interrepair maintenance period.

UDC 621.313

O.M. POPOVYCH, Dr. of sciences, Associate Professor,
I.V. GOLOVAN, PhD (Engineering), The Institute of
Electrodynamics of the National Academy of Sciences of Ukraine,
pr.Peremohy, 56, Kyiv, 03057, Ukraine

MATHEMATICAL SOFTWARE WITH INCREASED EFFICIENCY FOR DESIGNING INDUCTION MOTORS OF ELECTROMECHANICAL SYSTEMS OF THE MINING INDUSTRY

The difficult working conditions of induction motors in the mining industry are often the cause of the constructional features of these motors. Making motors in small batches also contributes to this. For these reasons, the design of induction motors has to be performed taking into account the wide field of variation of constructional schemes and parameters.

The mathematical models used in practice for designing induction motors are mainly based on electrical circuit analysis methods. They provide the necessary accuracy of analysis due to the correcting of mathematical models using empirical dependencies. But, these dependences are obtained for a limited area of change of parameters and modes. It is necessary to expand the range of changes in design parameters [1] for mining motors, but to ensure the required

accuracy, a long-term physical experiment is needed, which has great cost.

Methods for analyzing processes in induction motors based on electromagnetic field theory provide greater accuracy of analysis without the need for a large-scale physical experiment under conditions of a large range of variation of the constructional parameters. But, they are very difficult to apply for design practically because of the limited resources of computing equipment by memory and speed. The reason of the great need in computing resources for field analysis is due to the constructional features of induction motors (the need to take into account the three-dimensional field distribution in the motor, induced currents in the rotor of the induction motor, and the non-linear properties of the magnetic cores lead to a large memory consumption) and specifics of design synthesis (the search of the objective function extremum in the designing leads to the need for multiple repetition of the computational experiment with changed constructional parameters, this is accompanied by a very long computation time for field methods). These problems are relevant when designing motors taking into account the work features as part of electromechanical systems, when it is necessary to solve differential equations and take into account the operation dynamics of both the motor and other elements of the system.

The Institute of Electrodynamics of the National Academy of Sciences of Ukraine (Kiev) developed and programmatically implemented methods and mathematical models that provide analysis with accuracy of field methods and speed of circuit methods for solving problems of the induction motors design as part of electromechanical systems.

Obtaining mathematical models with increased efficiency for designing induction motors of electromechanical systems is carried out in several stages. At the first stage, the field analysis of the processes in the motor is performed by varying the values of currents and frequencies of rotor rotation in a given range of their changes. The analysis is performed in two orthogonal planes. The results of the analysis are consistent, which is equivalent to performing a three-dimensional field analysis [2]. According to the results of the analysis, using the developed expressions, two-dimensional

dependencies of the parameters of equivalent circuit of the induction motor in function of currents and slip [2] are formed. A mathematical model of the induction motor for the MATLAB simulation system using these dependencies [2] has been developed. It allows to conduct research taking into account the features of operation modes as part of an electromechanical system.

The advantage of the developed research method is the high accuracy of the analysis of motor operating conditions in a wide range of slip variation while minimizing the number of field calculations. So, for the 4A80A2U3 induction motor, field calculations were performed at eight slip values, for 12 stator current values at each slip (the average time of a single calculation on a computer with a 2 GHz frequency was 3 minutes). This lets to obtain the dependences of the electromagnetic parameters of the motor, the use of which in the analysis of the nominal and starting modes providing the error in calculating the values of the torque and stator current within 1%. In this case, as an initial information for obtaining a mathematical model, only the catalog winding data of the motor, characteristics of electrical materials are used.

The obtaining refined mathematical model is effectively applied in the study of the modes of the electrical network operation in the direct start conditions of a powerful induction motor [3].

References

1. Popovych O.M., Golovan I.V. Vrahuvannja masyvnyh elementiv mahnitoprovodu pry proektuvanni asunhronnyh machyn/ Pr. In-tu elektrodinamiky NAN Ukrainy: Zb.nauk.praz. –2008. – Vyp..21. – c. 36-46.
2. Popovych O.M., Golovan I.V. Refinement of analysis operation of induction motors as part electromechanical systems using equivalent field models using electrical circuits. *Tekhnichna Elektrodynamika*. 2014. No 5. Pp. 113-115. (Ukr)
3. Butkevych O.F., Chigenko O.I., Popovych O.M., Trach I.V. Vplyv FACTS na regim elektrychnoi merezi za prjamogo pusku potuznoi asynhronnoi maschjnj u skladi kompleksnoho navantagennya. - *Tekhnichna Elektrodynamika*. – 2018. - № 6. – C. 62–68.

UDC 681.326.7:532

S.V. ZAICHENKO, DSc (Technical Sciences), Professor,

S. M. STOVPIK, DSc (Technical Sciences), Professor,

S. P. SHEVCHUK, Professor,

Igor Sikorsky Kyiv Polytechnic Institute, Ukraine

DEVELOPMENT OF MECHATRONIC DIAGNOSTICS PIPELINES

The current stage of development of the means for identifying properties and the diagnosis of technical objects is characterized by the application of the latest achievements of mechanics, information technology, electrical engineering and control theory. Application of such directions of development of science and technology in combination with geography and geology has allowed creating qualitatively new directions of technical progress: geoinformatics (geoinformation systems), telemetry of wells, intrathoracic defectoscopy, etc. These systems are integrated computer systems that are managed by analysts who collect store, manipulate, analyze, model, and display spatially correlated data. Due to the presence of characteristic features such as IT technology, electronic systems, control systems, different types of sensors, mechanical, optical and other information gathering systems, such systems can be classified as mechatronic. Such robotized information systems have successfully proved themselves in studies in which the presence of a person is complicated: the exploration of volcanoes, wells, deserts, seabed, oil and gas storage and others [1].

One of the main indicators that determine the reliability of the pipelines is the actual position of the pipeline. Establishing the difference between the design design of the pipeline and operational data allows us to control, diagnose and predict the stress-strain state of the building.

A particular complexity in the determination of the position of mechatronic systems is the determination of the position of the center of the reference system by the accelerometer values by means of the

double integration of the values of acceleration over time [15-18]. As a result of noise and distortion of data related to vibration, change in position and tilting of the sensor, significant measurement errors (up to 20 m) arise.

Simplification of the system of gathering and processing information with increased accuracy of the data obtained by using modern microelectronic systems (for example, using the dependence of the coordinate of the point in space in the transition from various coordinate systems: the initial and current).

When moving the diagnostic complex along the pipeline, the position of the sensors constantly changes due to the inequality of the contact surface of the wheels. The area with located distance sensors and a gyroscope, moving moves relative to the initial position and returns to the angles around the axes of the original coordinate system OX, OY, OZ (Fig. 1).

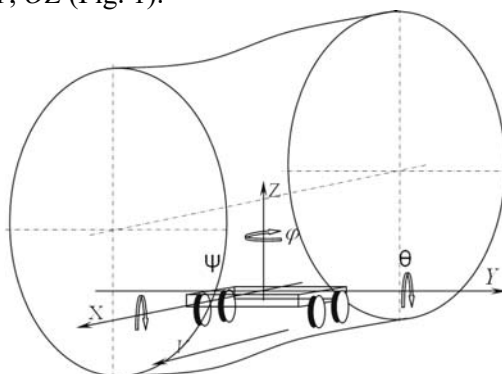

Fig. 1. Scheme of motion of the mechatronic complex

To describe the position of the complex in a three-dimensional space, 6 parameters are required. The coordinates x, y, z and the Euler angles φ, ψ, θ (Fig. 2) are chosen as parameters describing the position of the site.

Among the various systems of the Euler angles, which describe the orientation of the body relative to the initial coordinate system, a

system whose rotation vectors is OX, OY, OZ, and O-polar axes are selected. These directions of rotation are called the angles of the roll φ , the pitch θ and the ψ rotation. The advantage of this system is the use of modern microelectronic systems (MPU 6050) when controlling the movement of devices.

The article proposes the use of the mobile complex for diagnosing the state of the pipeline, which will ensure the conduct of research in difficult conditions with minimal cost. The case of spatial motion of the diagnostic complex in the lower part of the pipeline, taking into account the possible congress from the bottom of the pipeline in the event of interference, is considered. Dependencies are proposed, which determine the coordinates of the trajectory of the complex and the axis of the pipeline along the Euler angles.

Using the obtained data allows us to verify the technological parameters of the main pipeline to the conformity of construction documentation with the definition of local displacements.

Comparing the data about the project position and obtained as a result of the diagnosis, it is possible to determine the actual position of the pipeline and refined data on its tensely deformed state with defining the type of defect.

In the future, the developed diagnostic complex can be used to study the intersection of pipelines in order to install dents, corrugations and poor-quality joints of pipes equipped with a distance sensor (lidar).

References

1. Bares, J. E., & Wettergreen, D. S. (1999). Dante II: Technical description, results, and lessons learned. *The International Journal of Robotics Research*, 18(7), 621-649.

UDC 621.833.65

O.R. STRILETS, PhD (Engineering), Associate Professor
National University of Water and Environmental Engineering,
Ukraine

JUSTIFICATION OF THE STRUCTURE AND OPERATION PRINCIPLE OF THE DEVICE FOR SPEED CHANGE BY THE EPICYCLIC GEAR TRAIN WITH A CLOSED LOOP HYDROSYSTEM AND ITS ENERGY EFFICIENCY

Considered well-known stepped and stepless devices for speed change control in mining and other machines and equipment in the form of speed boxes. On the basis of the analysis of the operation of speed change devices, many deficiencies have been identified. The main disadvantages of stepped speed control are the complexity of device designs, their large material capacity, large dynamic loads that arise when switching from one speed to another, and the difficulty of automation. Stepless speed control is characterized by significant wear of machine elements caused by the use of friction brakes and locking friction clutches. As a result, the durability and reliability of parts of drives and machines in general is reduced. Therefore, the task of creating new speed change management devices that would eliminate these shortcomings arises. The development at the level of the invention of the cargo-stop gear in the form of a closed hydrosystem and its application in the gear differentials, which are the subject of special curiosity of the world's scientists, has led to the creation of new devices for speed variations control.

The structure and operation has been described of a closed loop hydrosystem, which consists of a hydraulic gear pump, short pipelines, a regulating valve, a reverse valve and a tank with a liquid. All components of the closed loop hydrosystem are connected respectively with each other and installed on the hydraulic pump. This hydrosystem operates as follows. When rotating the shaft, the hydraulic pump pumps the liquid in a closed loop consisting of pipelines, return valve, tank for the liquid and regulating valve – when the last is open. If the regulating valve is closed, then the closed loop hydrosystem is closed, thus, the hydraulic pump is

stopped and, at the same time, the link connected to hydraulic pump is installed will not move. This principle of the operation of a closed loop hydrosystem is used to control the angular velocity of a driven link of the epicyclic gear train through the change in the velocity of one of the control units due to the throughput of a liquid moving in a closed circuit hydrosystem through a control valve. Therefore, the angular velocity of the control link ω_c varies from 0 to $\omega_{c\ max}$. Refill of the hydrosystem by liquid is carried out from the tank through a reverse valve.

It is known that the gear differentials consist of a sun gear, planets, a ring gear and a carrier mounted on the frame. Out of three links, namely, sun gear, ring gear and the carrier, there may be one driving - connected to the engine, second driven - connected to the working body of the machine, and the third control - connected to a closed loop hydrosystem at the expense of which the speed of the driven link can change in the forward direction and vice versa.

The proposed speed control by the epicyclic gear train has been considered for cases through the sun gear [1], or ring gear [2], or the carrier [3].

If the speed change is performed through the sun gear, then its shaft is connected with a closed hydraulic system. If the driving link is the ring gear ($\omega_3 = \text{const}$) and the driven is carrier, then by changing the speed of the sun gear ω_1 , which varies from 0 to $\omega_{1\ max}$, with the help of a closed loop hydrosystem, it will smoothly change speed of the driven link - carrier (ω_4). Similarly, a change in speed in the opposite direction will be performed when the driving link is being carrier, and the ring gear is driven.

For other cases of control link, the operating principle is similar.

The theoretical and computer research of the energy efficiency of the considered gear differentials in the devices for speed change through the sun gear, or ring gear, or carrier by the definition of the performance efficiency coefficient (PE) is given.

The PE for planetary gear trains, the components of which are epicyclic gear trains, is determined in practice by the frictional losses in each gearing. T

hese losses are proportional to the product of the circular force on the teeth and the velocity of the point of the initial circle of planets

relative to the carrier, or the product of the torque of this force at an angular velocity.

This product is called potential power and is used in determining the PE of single-stage gear differentials with different combinations of driving, driving and control links.

On the basis of this technique, analytical expressions have been obtained for determining the PE of gear differentials in speed change devices, and using computer programming - graphical dependences on the speed of the driving link, the gear ratio and the speed of the control link.

The obtained graphical dependencies of PE allow us to draw conclusions about the energy efficiency of such transmissions and the possibility of self-braking and their application in technology.

In this report, attention is also drawn to multi-stage epicyclic gear trains that extend the range of speed variations, for example [4].

Taking into account the complexity of the problem, theoretical and computer researches of efficiency of multi-stage epicyclic gear trains in the devices of speed change with closed loop hydrosystems on the examples of two and three-step gear-boxes have been executed. In example transmission, the first-stage carrier was connected with the second-stage sun gear.

Speed control is carried out at the expense of ring gears of the first and the second stages with the help of hydrosystems installed on them.

The driving link of such a two-stage differential transmission is the sun gear of the first stage, and the driven link – carrier of the second stage.

Other schemes of two- and three-stage epicyclic gear trains have been considered in relation to driving, driven and control links.

Similarly, as for single-stage programs, the analytical expressions obtained for the PE have been programmed and using the PC obtained graphs that allow to add conclusions about the dependence of efficiency from the number of stages.

References

1. Strilets O.R. The efficiency of the differential gear of devices for speed change control through a sun gear. Odessa Polytechnical University. Works. iss. 2(52), 2017, pp. 29-38.

2. Malashchenko V., Strilets O., Strilets V. Justification of efficiency of epicyclical gear train in device for speed changes management. Ukrainian Journal of Mechanical Engineering and Materials Science. vol. 3, no. 1., Lviv, 2017, pp. 89-95.

3. Malashchenko V., Strilets O., Strilets V. KKD zubchastoi dyferentsialnoi peredachi u prystroi dlia keruvannia zminamy shvydkosti cherez vodylo. Bulletin of NTU "KhPI". Series: Problem of mechanical drive. no. 25(1247), Kharkiv, 2017, pp. 97-102.

4. Malashchenko V., Strilets O., Strilets V. Determining performance efficiency of the differential in a device for speed change through epicycle. Eastern-European journal of enterprise technologies, no. 6/7 (90), Kharkiv, 2017, pp. 51-57.

UDC 622. 17:504.064.4

A.G. MNUKHIN, Doctor of Technical Sciences, Honored Inventor of Ukraine, Academician of the Ukrainian Academy of Sciences, Zaporizhzhya State Engineering Academy, Ukraine

A.A. HITULIAR, Postgraduate Student, Department of Metallurgy, Zaporizhzhya State Engineering Academy, Ukraine

NEW METHODS OF SEISMIC EXPLORATION ON THE BASIS OF HYDRAULIC BLASTING TECHNOLOGIES

The presence of hundreds of coal mines whether operating or even closed ones on the territory of today's Ukraine is inextricably linked with the inefficient use of promising Ukrainian lands, as well as with the deterioration of the ecological situation in the area. In addition, it is known that these large number of waste piles do not just occupy areas that could be successfully used in the national economy, but also contain themselves a number of useful ingredients, including expensive, such as germanium, gallium, scandium, yttrium, zirconium, aluminum, iron, etc., in quantities acceptable for industrial mining. All that presents a sufficient basis for the close attention of the technical specialists to this type of raw material. The aim of the work is to develop new highly efficient methods and means for carrying out analytical studies of mining waste, implemented in the form of waste dumps. For many decades of its existence, the coal industry of Ukraine has accumulated a huge amount of industrial waste, that is, taken from the bowels of the earth in the form of rock mass, the so-called waste dumps or waste piles. It is known that the ratio between the volume of solid fuel extracted

and rock mass left on the surface is about 2.86, therefore, the total number of waste piles both left indefinitely and in the process of formation currently in Ukraine exceeds 1,800 facilities. The average volume of such piles is usually $1.8 \cdot 10^6 \text{ m}^3$ and has a mass of $2.1 \cdot 10^6 \text{ t}$.

It is known that each dump contains up to $400 \cdot 10^3$ tons of iron ore, up to $300 \cdot 10^3$ tons of aluminum containing raw materials, up to $100 \cdot 10^3$ tons of germanium oxide with a total cost of about \$ 100 million and a number of accompanying rare-earth metals weighing up to 500 tons (gallium, scandium, yttrium, zirconium). In addition, waste dumps of Ukraine are also promising due to the presence of 14.90% Al_2O_3 of aluminum alumina and aluminum ore - 20.65% of Fe_2O_3 in industrial quantities of raw materials.

This task can be solved by taking a large number of samples from specific dump points, but taking into account the geometrical dimensions of the latter, related to the occupied area and height of the embankment, this type of geological exploration is very long, time-consuming, and therefore, expensive. Hence, it is more expedient to use excitation methods in its mass of seismic vibrations to determine the waste dumps and above all its homogeneity by applying external dynamic loads in the form of explosive or non-explosive, for example, pneumatic or electromagnetic oscillations of sufficient power to the object.

However, in recent years, seismic exploration based on new methods has gained wide industrial development in a number of countries such as the United Arab Emirates, Egypt, Saudi Arabia, the United States, etc. The following issue is how this direction of research will be developed in the countries of the former CIS and, particular, in Ukraine. There are two probable and even possible scenarios here. The first one is common, being based on transition to foreign technologies and their implementation, once they become familiar; the second scenario is to do autonomous research, develop original breakthrough techniques that, in particular, can be used to survey waste piles for the purpose of their further processing, being today one of the main promising areas of work of the domestic mining industry.

The proposed solution relates to the technical means that allows seismic survey of the earth's crust without any its digging to predict

the chemical composition in a particular place using the method of incident and reflected waves. However, these methods, based on standard shock and explosive equipment, are very laborious, insufficiently accurate and, in addition, the use of conventional explosives to excite earth crust oscillations makes it difficult to use the generally progressive method in field conditions, especially when studying objects of conical shape, for example, waste dumps.

When developing seismic prospecting methods, it was taken into account that the closest to the devices using conventional explosives are functionally suitable electro-hydraulic installations, that is, installations using discharge-pulse technologies (electric explosion), which is accompanied by shock waves and ensures the occurrence of pressure $(15-20) \cdot 10^3$ atmospheres, which are safe and do not require safe and protective measures in the process of their implementation. However, their direct application for this purpose requires the additional creation of specialized recording, synchronizing, that is, control systems equipped with special seismic sensors. The algorithm of the work of the system being developed first is the following. The working body of the electro-hydraulic installation, is installed in the hole, drilled vertically at the top of the studied dump (waste). In the same hole the water line (hose) of the pump is installed. Seismic sensors are located in other vertical holes of the waste pile. Based on its functional features, the proposed system refers to the technical means that allow seismic exploration of the earth's crust, in this case the waste, without any digging to predict its composition in a particular place using the method of incident and reflected waves. As noted earlier, all other methods based on standard shock and explosive equipment are very laborious, insufficiently accurate and, in addition, the use of traditional explosives to excite vibrations of the Earth's crust makes it necessary to follow fairly strict rules for the storage and use of explosives makes it difficult to use this generally progressive method in the field, especially when studying objects of conical shape, for example, rock dumps.

As a result of the actions performed on the mountain-mass, after standard processing of the obtained data in the form of the parameters of their own, forced and other vibrations arising in the array of wave processes, the boundaries of the field density are

determined, and the conclusion is made concerning the homogeneity or heterogeneity of the waste material on the basis of which the analysis of its composition is done. The proposed new approach to study the Earth's mass and, in particular, the rock dumps of coal mines can significantly improve the efficiency and speed of seismic survey while simultaneously increasing the safety of geological survey by eliminating conventional explosives and associated with it prohibitions and restrictions.

UDC 62-592.2

V.M. STRILETS, PhD (Engineering), Professor,

M.M. KOZIAR, Doctor of Pedagogy, Professor,

V.A. VOLSKY, Student,

National University of Water and Environmental Engineering,
Ukraine

JUSTIFICATION OF THE DESIGN, STRUCTURE AND PRINCIPLE OF OPERATION OF THE BRAKE IN THE FORM OF A CLOSED LOOP HYDROSYSTEM AND ITS INSTALLATION ON THE DRIVE SHAFT

For reliable operating of mining, load-lifting, transporting and other machinery and equipment, the devices necessary that ensure the safety of their normal operating. The process itself of operating of these devices is called braking, and devices - brakes. Brakes, for example, in lifting mechanisms, should stop these mechanisms and keep the cargo at certain height, and also provide a slow lowering of the cargo at a regulated speed. Mechanisms of movement and turning of machines use brakes to stop them on a given path. In conveyors and elevators, the brakes are used to stop these machines and prevent their reverse movement. The structure and principle of work of block, tape, disk and cargo-stop brakes are widely described in technical literary sources, for example, [1]. The main drawbacks of such brakes are the complexity of the design, the use of frictional joints, which lead to intensive wear of parts, and non-productive energy costs, for example, when lowering cargos. The current scientific and technical task is the development of new brakes, which

are constructively simpler and exclude frictional connections. Therefore, a new brake is proposed, in the form of a closed loop hydrosystem, developed at the level of patents for inventions [2,3], which eliminates the specified disadvantages.

The structure of the brake, which consists of a hydraulic gear pump, short pipelines, a regulating valve, three return valves and a tank for a liquid, is considered. Hydraulic brake system has two closed loops. All component parts are mounted on the frame of a hydraulic gear pump. We will demonstrate the operation of such a brake on the example of the cargo lifting mechanism. When rotation of the drive shaft of the mechanism is in the direction of cargo lifting, the gear pump shaft is put into operation and pumping the liquid through the first closed loop. At this time, the regulating valve closes the second loop of the hydraulic system. When the lifting finished, the cargo stops and its own weight creates a reverse torque. This changes the direction of rotation of the hydraulic gear pump. Since the second loop of the hydrosystem is closed by the regulating valve, the raised cargo is in a suspended state.

To lower the cargo, the regulating valve opens. The fluid moves along the second closed loop, namely through a gear pump and an open regulating valve. At the same time, the gear pump and drive shafts rotates in the opposite direction – the cargo gradually drops. When the regulating valve is closed, the hydraulic system stops, the flow of the liquid stops on the second closed loop of the hydrosystem, and then the lowering of the load stops. Two return valves serve to direct the flow of fluid in the loops of the hydrosystem, and one to fill the hydraulic system with a liquid from the container.

It is proposed to attach the brake to the drive due to the profile elastic connection of the valves on the support [4], which has the following structure. From the end of the supporting area - the spindle of the drive shaft, a coaxial axial cylindrical hole is made, for example, with four longitudinal semicircular grooves axially located on the inner surface. In this hole a profiled sleeve is installed in the form of a square with hollow circular vertices, with outer-sized dimensions equal to or very less larger than circular grooves. The profiled sleeve is mounted in a coaxial axial cylindrical hole with a small tension of hollow circular vertices that are part of the circular grooves.

The profile shaft is equipped with a brake shaft - a six-row hydraulic pump that joins, respectively, with a square profile.

The elastic connection of the shafts on the support works as follows. The torque from the shaft of the drive is transmitted through the profiled sleeve to the brake shaft or vice versa.

An increase in the torque leads to a deformation of the profiled sleeve due to the squeezing of its faces and hollow circular vertices of square.

This results in a decrease in the large shock dynamic loads.

The elastic connection of the shafts on the support is more reliable when brakes are used in rigid operating modes.

This brake improves the performance of the mechanisms due to its simplified control capability, increases the longevity of the parts of the drives due to the absence of friction pairs, and when the cargo is lowered in load-lifting machines energy costs is also reduced.

References

1. Malashchenko V.O., Strilets V.M., Novitsky I.M., Strilets O.R. Detali mashyn i pidiomno-transportne obladnannya. Rivne : NUWEE, 2017. 327 p.
2. Kudenko M.M., Strilets V.M. Ostanov dlia gruzha, peremeshchaemogo mekhanizmom pod'ema. Pat. No. 2211796 RU, 2003.
3. Kudenko M.M., Strilets V.M. Vantazhoupornyi zupynnyk. Pat. No. 44135 UA, 2005.
4. Strilets O.R., Malashchenko V.O., Strilets V.M., Savluk A.P. Z'yednannya valiv na opori. Pat. № 125585 UA, 2018

UDC 681.3 (07)

O.V. BANZAK, D.Sc., associate professor, Odessa state academy of technical regulation and quality, Ukraine.

G.V. BANZAK, Ph.D., Odessa state academy of technical regulation and quality, Ukraine

IMITATIONAL STATISTICAL MODEL OF TECHNICAL SERVICE PROCESSES OF MINING EQUIPMENT

A characteristic feature of complex technical objects to which the mining equipment belongs is the presence in their composition of a large number of different types of component elements, which have a different level of reliability, different laws of the processes of their wear and aging.

This feature requires a more subtle approach to the organization and planning of maintenance during their operation.

The developed simulation statistical model (SSM) is designed to obtain estimates of reliability and cost of mining equipment, taking into account its composition, structure and reliability, and taking into account the maintenance. The model should reproduce (simulate) the process of technical operation, which is formally described by the state and transition graph.

Monitoring the performance of mining equipment is carried out continuously. A diagnostic control is performed, as a result of which the technical condition of the elements of the object is determined. Depending on the result of this control is carried out or not carried out.

SSM is based on the method of simulation statistical modeling, using the concept of "calendar of events". The essence of the concept of the calendar of events and the mechanism of its application is as follows. An array (representing the calendar of events) is created in the RAM (PC) of the PC, in which the values of the scheduled time points of all the simulated events are recorded.

In the process of modeling, periodically "view" of all the elements of the array, and the definition of the smallest of the planned points in time. The found minimum value is taken as the current model time, and the corresponding event is taken as the current event. Then the "processing" of the current event is performed, which consists in imitating the actions that constitute the essence of this event.

The model simulates (and processes) three types of events: "failure" (transition $0 \rightarrow 1$), "control" (transition $0 \rightarrow 2$), and "M" (transition $0 \rightarrow 3$). After each event is processed, the next event of the next type of event is scheduled. If the current event is a "failure", then a random running time of the same (failed) element is generated until the next failure. If the current event is "control" ("M"), the time of the next corresponding event is scheduled. Obtained new values of the scheduled time are recorded in the calendar of events instead of their previous values. The described process of analyzing and modifying the calendar of events repeats cyclically throughout the entire simulation time.

The verification of SSM was performed as follows. The correctness of the simulation of the failure-recovery process was checked by comparing the simulation results with the exact calculated values of mean time to failure, obtained for an individual element. The instrumental accuracy of

the model obtained in this way, estimated by the value of the relative error, was less than 1%. The correctness of the algorithms for simulating maintenance processes was checked qualitatively (by the consistency of the obtained simulation results).

The methodical accuracy of SSM is determined by such factors:

the initial reliability of the object (given by the indicators of the reliability of the elements);

the number of implementations (duration) of the simulation;

the specified duration of operation of the object.

Of these factors, the most significant is the first. In most practically interesting cases, the relative error of the simulation results does not exceed 10–20%.

Thus, in this paper, SSM was developed to predict the reliability and cost of operation of complex technical mining equipment, depending on the parameters of the selected maintenance strategy. The SSM implements algorithms for simulating maintenance processes for three variants of maintenance strategies: maintenance “by state” (MS) with a constant frequency of control; MS with an adaptively varying frequency of control; regulated maintenance.

The mode of modeling the regulated maintenance is introduced to ensure the completeness of the analysis of possible maintenance strategies of the designed mining equipment and to predict the possible gain in reliability and cost of operation of the mining equipment through the application of MS strategies.

UDC 622.24.051, 622 ‘156

O.P. VYNOHRADOVA, Ph.D (Engineering),

O.S. VASYLCHUK, graduate student,

A.L. MAYSTRENKO, doctor (Engineering), correspondent member NASU, prof.,

V. Bakul Institute for Superhard Materials NASU, Kyiv, Ukraine

THE MECHANISM OF WEAR OF DIAMOND-CONTAINING COMPOSITE IN DRILLING TOOLS

The degree of conformity of wear resistance of a diamond containing composite of drilling and cutting tools to the abrasive properties of rock is one of the main criteria for choosing the

chemical composition of the diamond containing composite and the operating conditions of the drilling tools. The detailed study of the mechanism of interaction a single destructive indenter with the matrix of diamond containing composite is possible to predict the degree of wear resistance and efficiency of the drilling tool.

Lu and other [1] submitted the testing of samples of composite diamond- containing tungsten-cobalt material (Co-6%, thickness of the diamond layer-approximately, 4 μm) by a diamond Rockwell analyzer with a radius of 50 μm , with loading variations of 10,15, 20,25 and 30 *N*. The purpose of the test was to investigate the mechanism of detachment of diamond coating on the tungsten-cobalt material.

The authors note, that the width of the damage (in the form of microgroove) of the diamond layer, increased with increasing load. However, the authors, illustrating the microgroove as a result of the applied loads on the Rockwell indenter, pointing on the width of the microgroove, do not comment the configuration of the microholes, which form the microgroove on the surface of the test specimen.

Commenting on the scanned electron microphotograph of the surface of a sample of a tungsten-cobalt diamond-containing material obtained after dynamic microindentation by the Vickers indenter at a load of 10,15,20 *N*, respectively, the author [2] concludes : there is a chemical redistribution of cobalt and carbon relative to the resulting microgroove.

As a result of the analysis of the samples of the products of the destruction of the carbide plate with a dynamic load (50 *N*) on one diamond grain, using a Lomo-Metam microscope equipped with a video camera, (V. Bakul Institute for Superhard Materials NASU) with the increase of the objective 360 times, the conclusion was made : the configuration commonality of solid particles [3] and fragments of products of rock (despite its physical and mechanical properties) as a result destruction by diamond grain [4] (with all components of the geometric parameters of configuration of single particle: the zone of introduction of indenter, the lateral parts and the final part) does evidence the identity of mechanisms of destruction of the solid alloy (WC + Co) and the rock as brittle materials.

Besides, according to the mathematical model of the formation of fragments of the rock by the diamond tool is due to the wave sequential-periodic decay of the micro-and macro-fragments of the slime [3], but on the surface of the face and surface of matrix of the drilling tool occurs the formation of microholes which form the microgrooves. The shape of these microholes is absolutely identical to the shape of the fragments of the rock.

As recent result of the microscopic examination of the matrix from Ni-Sn (6%) as well, with the addition of copper in drilling diamond containing instrument have shown, the mechanism of wear of a matrix as a result of drilling by diamond tools, is identical to the mechanism of the brittle destruction of a hard alloy.

The direction of the formation of the microholes in the microgroove is opposite to the direction of movement of the drilling instrument.

A distinctive feature of the matrix with a different chemical composition is the range of the overall dimensions of the microholes in microgroove on a work surface of instrument.

The fundamental size of single microhole on a work surface of instrument, at this stage of the study, is the width of the formed microholes. The range of variation of the width of microholes on the work surface of drill bit, equipped by inserts from "Slavutych" (composite consists from WC+Co (6 %) and a grain of diamonds 800/630 μm and their relative concentration of 100 %) when drilling sandstone of Torez field at optimum operating conditions is up 12-30 μm with the predominance of 21 μm wide microholes.

The width of a microholes which form the microgrooves on a surface of drilling bit with matrix from Ni Sn (6%) comes to 100 μm with the predominance of 43 μm wide microholes.

Therefore, matrix from Ni Sn (6%) less wear resistant. compared to the tool with a matrix of hard alloy.

